

# EASY LOUDNESS

## Digital Audio Processor

Manual

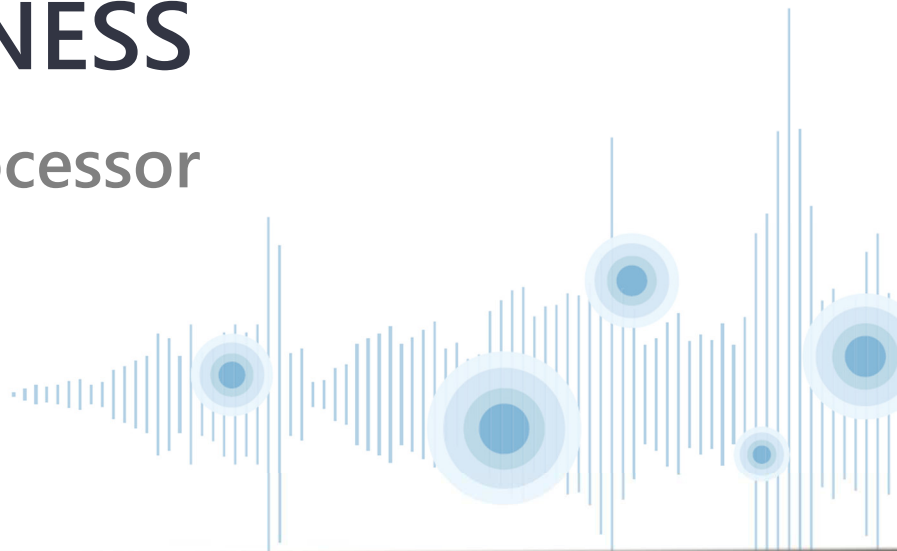







Hardware Features

- **1RU** compact 19" processing device
- **Dual power supply** second power supply for redundancy
- **Remote Panel** optional X\*AP RM<sub>1</sub> panel
- **Audio input** balanced/unbalanced AES – manual selection
- **Audio output** balanced/unbalanced AES
- **One interface slot** I/O expansion slot for one option board at a time
- **RJ45 network connector** 100BaseT full duplex Ethernet interface
- **USB B connector** built in USB < > serial adapter to access the device service port
- **8 GPI/Os** 8 balanced inputs, 8 relay closure combined on a 25pin D-Sub
- **Aux power supply** isolated 5V supply for external wiring
- **External sync IN** 75Ohm input (Word Clock, AES, Black Burst, Tri-Level)
- **Sync OUT** 75Ohm Word Clock output

The **EASY LOUDNESS** may be purchased with **SDI** or **AES67/Dante** interface.

Software Features in general

- **LevelMagic** loudness management according to ITU BS.1770-1/-2/-3  
EBU R128, ATSC A/85, ARIB TR-B32, Free TV OP-59, Portaria 354
- **Fail Over** automatic switch over with signal loss detection
- **Loudness measurement** in reference to the selected standard
- **SNMP agent** SNMP v1, see **D\*AP4-MIB**
- **Remote control** EmBER plus protocol or **X\*AP RM1** remote panel, mobile UI and legacy GPI/Os

## Content

	<u>page</u>
Introduction .....	2
<b>EASY LOUDNESS</b> front panel view .....	3
<b>EASY LOUDNESS</b> rear view .....	3
Block Diagram .....	4
Audio Processing Blocks .....	5
Control, Operating & Event Concept .....	5
Getting Started – Snapshot Concept .....	6
Getting Started – quick start guide .....	6
Getting Started – IP setup in general .....	7
Getting Started – IP setup of the <b>EASY LOUDNESS – via console interface</b> .....	7
Getting Started – IP setup of the <b>EASY LOUDNESS – via web browser</b> .....	8
Setup GUI – connecting with the <b>EASY LOUDNESS</b> .....	9
Setup GUI – SYSTEM – <b>System Status</b> .....	10
Setup GUI – SYSTEM – <b>Overview</b> .....	11
Setup GUI – SYSTEM – <b>Admin</b> .....	11
Setup GUI – SYSTEM – <b>Setup</b> .....	14
Setup GUI – SYSTEM – the <b>preset concept</b> in detail .....	15
Setup GUI – SYSTEM – <b>Preset Cleanup</b> .....	16
Setup GUI – SYSTEM – <b>SNMP</b> .....	18
Setup GUI – SYSTEM – <b>Backup / Restore</b> .....	18
Setup GUI – SYSTEM – <b>Firmware Update</b> .....	19
Setup GUI – SYSTEM – <b>Reboot</b> .....	20
Setup GUI – <b>INTERFACES</b> .....	20
Setup GUI – INTERFACES – <b>AES I/O</b> .....	20
Setup GUI – INTERFACES – SDI I/O Interface – <b>Overview</b> .....	22
Setup GUI – INTERFACES – SDI I/O Interface – <b>Local Routing</b> .....	23
Setup GUI – INTERFACES – SDI I/O Interface – <b>Setup</b> .....	34
Setup GUI – INTERFACES – SDI I/O Interface – <b>De-Embedder</b> .....	25
Setup GUI – INTERFACES – SDI I/O Interface – <b>Embedder</b> .....	25
Setup GUI – INTERFACES – Dante I/O Interface – <b>Status</b> .....	26
Setup GUI – INTERFACES – Dante I/O Interface – <b>Inputs</b> .....	28
Setup GUI – INTERFACES – Dante I/O Interface – <b>Ouputs</b> .....	29
Setup GUI – INTERFACES – Dante I/O Interface – <b>Network</b> .....	29
Setup GUI – AUDIO PROCESSOR – <b>Overview</b> .....	31
Setup GUI – AUDIO PROCESSOR – <b>Input</b> .....	32
Setup GUI – AUDIO PROCESSOR – <b>Fail Over</b> .....	32
Setup GUI – AUDIO PROCESSOR – <b>Level Magic</b> .....	33
Setup GUI – AUDIO PROCESSOR – <b>Output</b> .....	34
Setup GUI – MESUREMENT – <b>Loudness</b> .....	34
Setup GUI – <b>SNAPSHOTS</b> .....	36
Technical Data – 4 Channel Audio Processor [ <b>EASY LOUDNESS</b> ] .....	37
Technical Data – Option Board SDI I/O (3G/HD/SD) [ <b>O_DAP_SDI_a</b> ] .....	38
Technical Data – Option Board Audio-over-IP DANTE™ [ <b>O_DAP_DANTE_a</b> ] .....	39
Technical Data – Rear Connectors – <b>pin assignment</b> .....	40
Technical Data – <b>GPI wiring</b> .....	41
<b>Safety Information</b> .....	42
<b>Warranty</b> .....	42

## Introduction

The **EASY LOUDNESS** is an entrance level processor that may be bought with a 3G/HD/SD SDI or an AES67/Dante interface.

This manual refers to an **EASY LOUDNESS** equipped with a SDI interface.

The **EASY LOUDNESS** focuses on automatic and adaptive loudness management compliant with all current broadcast audio loudness recommendations including ITU.1770 standards (revisions 1, 2 and 3) as well as recommended practices ATSC A/85 (2011/2013), ARIB TR-B32, Free TV OP-59, Portaria 354 and EBU R128. The **EASY LOUDNESS** features loudness normalization for up to two stereo programs of audio. The Level Magic™ is based on a unique multi-loop control principle.

### LEVEL MAGICII™

The algorithm offers adaptive wideband control with exceptionally high audio quality uncompromised loudness management without any coloration, pumping, distortion or modulation effects by combining three major gain changing elements:

- Transient Processor
- Adaptive AGC
- Distortion-free true peak limiter

### System Integration

All system parameters are remotely accessible, allowing the unit to be integrated and remotely controlled by broadcast control systems. This helps users to apply individual processing to their programs, which is a key feature for well-managed loudness control.

### Loudness measurement

To check compliance of programs with your local loudness regulations, the unit analyzes loudness and true peak levels from input signals and may transfer the measurement data via Ethernet to an optional measurement and logging software anywhere in your network. These measurements can be triggered by automation systems via GPIs, via network or even manually on the **X\*AP RM1** remote panel.

The **EASY LOUDNESS** can also generate SNMP or GPI/O alarms in case pre-determined limits are exceeded.

### Web configuration

A web interface also allows easy and intuitive setup and configuration anywhere in your network.

### Interfaces and system security

Audio I/Os range from one onboard AES I/O to either a 3G/HD/SD-SDI I/O including video delay or an AES67/Dante AoIP interface. The SDI interface has a power fail bypass relay as standard. With redundant PSU and SNMP integration the unit ensures maximum operational safety.

## EASY LOUDNESS front panel view



The front panel of the **EASY LOUDNESS** has four LEDs to show the general summarized status as well as power supply and audio bypass (maybe activated by an X\*AP remote panel only).

## EASY LOUDNESS rear view

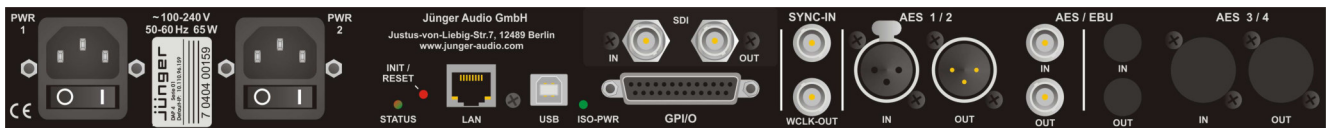

For fail safe operation, the **EASY LOUDNESS** provides two independent power supplies. These power supplies operate in load balance.

- STATUS** shows the status of the device controller.
- INIT / RESET** pressing the INIT button briefly will warm start the device controller. Holding down the button until the **STATUS** LED flashes 5 times will initialize the **EASY LOUDNESS** to factory default.
- LAN** RJ45 socket for Ethernet connection to a LAN.
- USB** USB 2.0 type B socket to connect the built in **USB >> serial** converter with an external PC
- ISO-PWR** lights green to indicate that the isolated 5V power supply for GPI /O application is available.
- Interface 1** slot to mount one of the optional interface boards (SDI, MADI, DANTE, AES, analog).
- GPI/O** 25pin Sub-D female connector to interface with the 8 optical isolated general purpose inputs and 8 solid state relay closure outputs.
- SYNC IN** 75Ohm BNC connector to connect with external sync sources.
- WCLK-OUT** 75Ohm BNC connector to synchronize external devices to the **EASY LOUDNESS** internal word clock.
- AES 1/2 IN / OUT** AES3 (XLR) and AES3id (BNC) input (selectable via GUI) / output (parallel)

Block Diagram

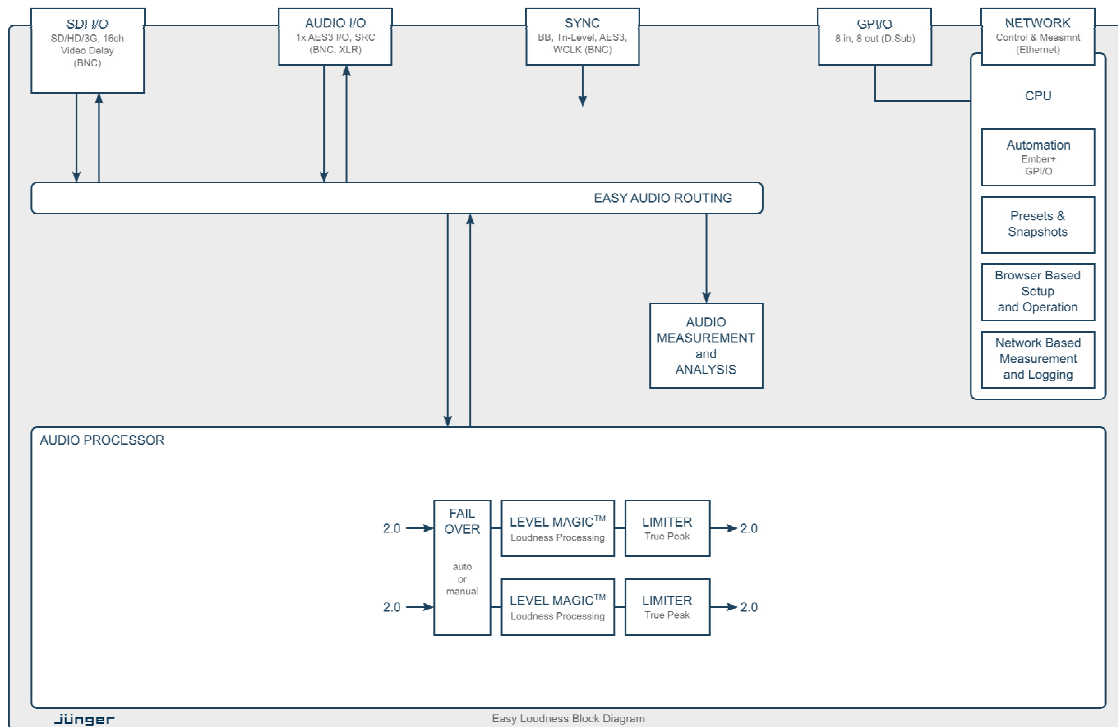

The above schematic shows the principal blocks of the **EASY LOUDNESS**.

The core of the unit is the audio processor with 4 inputs and 4 outputs.

An AES I/O on the motherboard is provided for digital line operation. The respective connectors have relay bypass for power fail operation. The bypass circuit may be disabled by an internal jumper. For the 2 channel version only one AES I/O is fitted.

An interface slot is provided to carry an optional 3G / HD / SD-SDI or an AES67/DANTE module. It allows for extremely flexible interfacing of the **EASY LOUDNESS** in TV installations.

The sync circuit can deal with all common formats to integrate the **EASY LOUDNESS** into digital facilities with a sample rate from 44.1 or 48kHz. Other devices may be synchronized by the word clock output of the **EASY LOUDNESS**.

The **EASY LOUDNESS** has 8 balanced **GPis** and 8 relay closure **GPO** contacts. This enables the user to simply recall presets or call events, change device configurations and report general status information.



## Audio Processing Blocks

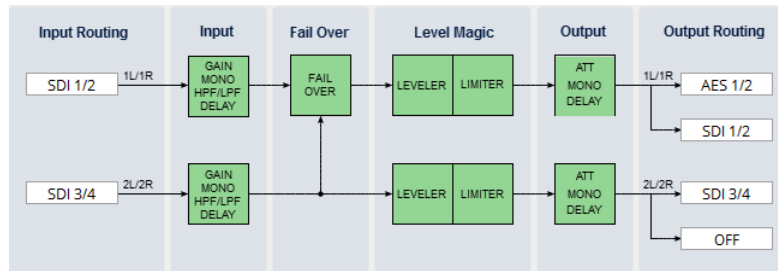

Above you see the various function blocks of the audio processor rendered by the **DSP** engine. Each function block has its representation in the GUI by individual tab sheets. You may simply click on the respective graphical area as an alternative way to navigate through the GUI.

It is important to understand that the physical input interfaces of the device (SDI DE-EMBEDDER, AES IN) must be routed to the **DSP** inputs in order to process. Similarly the **DSP** outputs must be routed to output interfaces (SDI EMBEDDER, AES OUT). You will find those settings by clicking on the **Home** tab. The factory default set-up will meet most situations for stereo broadcast applications.

## Control Concept

Communication between external applications or the **X\*AP RM1** remote panel, is based on **TCP/IP over Ethernet**.

The setup GUI utilizes web technology. The functionality of the web GUI is optimized for **Firefox**.

The setup GUI can be complemented by other application programs running on MS Windows® XP, W7, W8 like the Junger Application Manager **J\*AM**. Operator access will also be available for mobile devices running an appropriate browser on iOS or Android.

An **SNMP** agent may be activated to incorporate the device into a station monitoring system.

For 3<sup>rd</sup> party remote applications, **Junger Audio** highly recommends using the **Ember+** protocol which is widely distributed in the European broadcast industry. The user community is also increasing rapidly world wide. By default, the **X\*AP RM1** remote panel and the **EASY LOUDNESS** "talk" Ember natively.

## Operating Concept

Further below you will see that the setup GUI for the device is grouped into several parameter areas. One can reach the parameters via three tier navigation by tabs which may have sub tabs.

Each function block (parameter area) has dedicated presets. The presets can be recalled at any time during operation, either by manual intervention, via the embedded web server (browser based GUI), automatically by the internal snapshot manager or by external applications.

For all relevant settings an **ON AIR** and a **PRESET** part exists. I.e. you may either edit the parameters **ON AIR** or **offline** for the respective part of the **EASY LOUDNESS**.

The presets of the **EASY LOUDNESS** are persistent by nature. You are working directly on the preset memory. I.e. you need not worry about storing such presets, the **EASY LOUDNESS** does it for you.

### Snapshot Concept

The **EASY LOUDNESS** incorporates a sophisticated snapshot management system. Snapshots may fire a combination of three presets and can control the measurement.

- \* **Routing Presets** for System set up, Interfaces, Routing
- \* **Level Magic Presets**
- \* **Measurement Presets** to control loudness measurement for the device

These events may be fired by **Triggers**.

Trigger sources may be GPIs and/or hotkeys of the **X\*AP RM1** remote panel, or the device error status information.

### Getting Started – quick start guide

Before the **EASY LOUDNESS** can be used, there are some basic configuration steps which must be followed in the order set out below. This example assumes you will process one stereo program that is embedded into SDI group1 Ch1/2.

- \* Connect the SDI signal (from a source like the station router or video server) to the SDI IN.
- \* Connect the SDI OUT connector to your destination device (station router or monitor box).
- \* Hook up the device to the station PC network
  - Consult your IT administrator for **assistance** if you are not sure about this procedure
  - Connect it to a switch or hub or directly to a PC / Laptop via an Ethernet cable (some PCs need a cross over [1:1] cable when connected with the D\*AP4 directly)
  - Find an unused IP address - ask your administrator!
  - Assign it that IP address and set the network mask accordingly, a gateway is optional (see next page for details)
- \* Open a browser (FireFox recommended) and connect with the device
  - Type in the assigned IP address as an URL: http://<ip-address>
- \* Check the routing to the Audio Processor (DSP)
  - Home > Input Routing > **1L/1R=SDI 1/2**
- \* Check the routing from the Audio Processor (DSP)
  - Home > Output Routing > **1L/1R=SDI 1/2**

Now you should hear your source stereo program signal at the destination and you may start experimenting with the various parameters of the **AUDIO PROCESSOR** blocks.

**Important Note!** The **EASY LOUDNESS** is factory default pre-configured for SDI I/O Group 1 (channels 1/2 and 3/4).

## Getting Started – IP setup in general

The process of installing an **EASY LOUDNESS** into an **IP network** is as follows:

1. Ask the system administrator for a unique IP address of the network, the respective netmask and gateway address
2. Assign the **EASY LOUDNESS** an IP address

You have 2 choices to assign the **EASY LOUDNESS** an **IP address**:

- \* Via the serial console interface
- \* Via a Web browser

**Important Note!** If you are not familiar with setting up devices for IP communication, we highly recommend you consult your system service or IT department to assist you.

## Getting Started – IP setup of the **EASY LOUDNESS** – via console interface

The tool to change the IP configuration of the **EASY LOUDNESS** can be selected via the console interface. You must connect it with the PC via an **USB A to B** cable. This will install the driver for the built-in **USB to serial converter**. Now you can open a terminal program. Here you must select the virtual **COM port** assigned by the OS. The communication parameters are: 115200kBaud, 8, N, 1, no handshake.

Pressing **<ENTER>** will open the console menu:

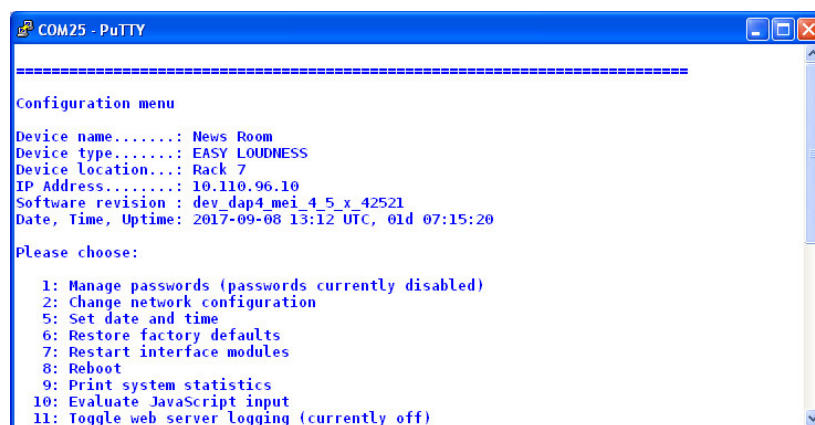

**[2017-09-08 13:12] Your choice:**

Select item "2": **<ENTER>**

### Current network configuration

**IP Address: 10.110.96.110**  
**Netmask ...: 255.255.0.0**  
**Gateway ...: 10.110.0.1**

### Enter new IP address, press ENTER to cancel:

You must enter the new IP address (e.g.): "192.168.178.78" **<Enter>**

### Enter new netmask, press ENTER to cancel:

You must enter the new netmask (e.g.): "255.255.255.0" **<Enter>**

### Enter new gateway address, press ENTER to configure without gateway:

You may press **<Enter>** to skip this point or you may enter the new gateway address (e.g.): "192.168.178.1" **<Enter>**

**Important Note!** The gateway entry is optional but you must take care that the gateway address matches the network mask related to the devices IP address! If you are not sure simply enter **0.0.0.0**. or leave it without an entry.

### Changing Network configuration

**Network configuration has been changed. Please reboot the device to activate the new settings.**

Select item "8: Reboot" <ENTER>

**Do you want to reboot the device ?**

Press small "y" <ENTER>

**Rebooting the device .....**

After reboot has finished, the new IP configuration is active and will be displayed at the top of the configuration menu.

### Getting Started – IP setup of the **EASY LOUDNESS** – via a web browser

- \* Read the **default IP address** printed on the label at the rear of the device.
- \* Set up network parameters of your PC to fit the default IP address of the **EASY LOUDNESS** (e.g. default IP +1 and net mask = 255.255.0.0).
- \* Connect the **EASY LOUDNESS** with the PC either by an Ethernet patch or a cross over cable (if the PC does not support Auto MDI-X) or via a switch.
- \* Open a browser and type the default IP address of the **EASY LOUDNESS** into the URL field and press <ENTER>. This will open the **HOME** tab sheet of the GUI.
- \* Click on <SYSTEM> and afterwards the "Admin" tab:

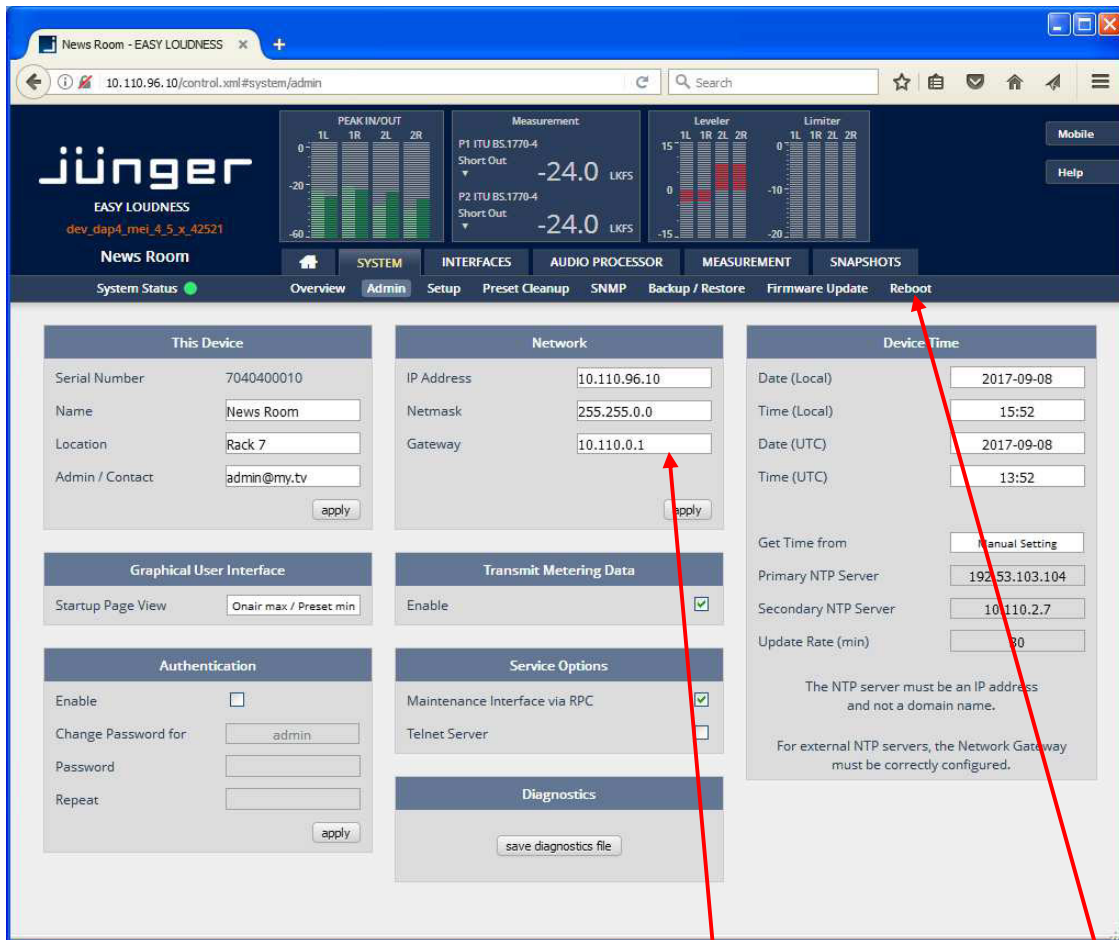

Enter the desired network configuration and press <apply> Afterwards you must reboot the **EASY LOUDNESS** in order to activate the new IP configuration.

**Important Note!** After reboot neither the **web browser** nor the **X\*AP RM1** remote panel may be able to communicate with the **EASY LOUDNESS**. You must change back the IP configuration of the PC to your actual network and fill in the **new** IP address in the URL field. You must set-up the **X\*AP RM1** remote panel as well to attach this device (see X\*AP manual for details).

## Setup GUI – connecting with the **EASY LOUDNESS**

You must open a browser and enter the **IP address** of the **EASY LOUDNESS** into the **URL** field and press **<Enter>**. The browser will retrieve the necessary information and open up the **Home** page:

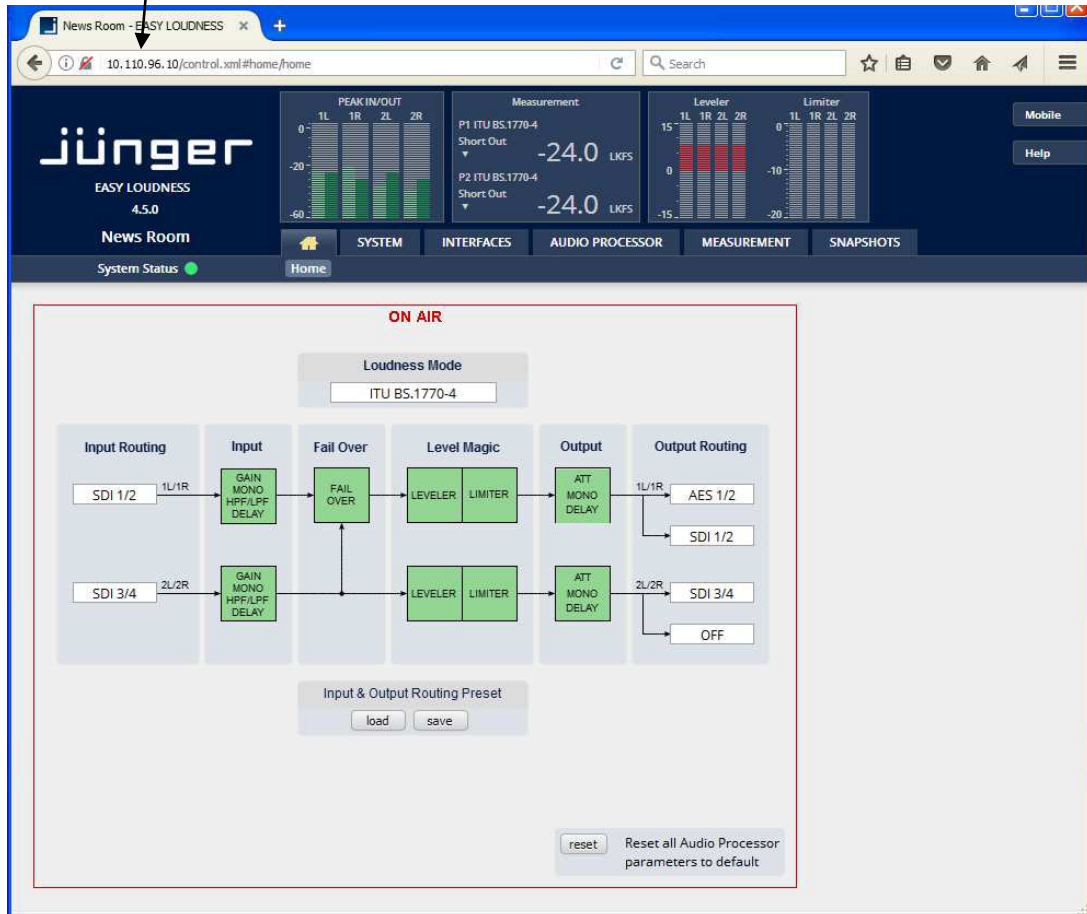

The entrance pane is the **HOME** page. If you are returning from other pages or if you reload your browser content (by pressing **<F5>**) it may show a different page due to the caching of the browser.

In the top section you see several bar graph displays for signal levels as well as for gain reduction display of function blocks.

On the following pages we will go through the various panes to show you the basic setup of the device.

You may set up the synchronization source. You may also give the device a name, tell it its location and define an administrative contact which may be used by the monitoring system of your house (e.g. via SNMP).

You may change settings of the installed interface module and the signal routing.

Setup GUI – SYSTEM – **System Status**

The system status is a special link you can reach independently from where you are:

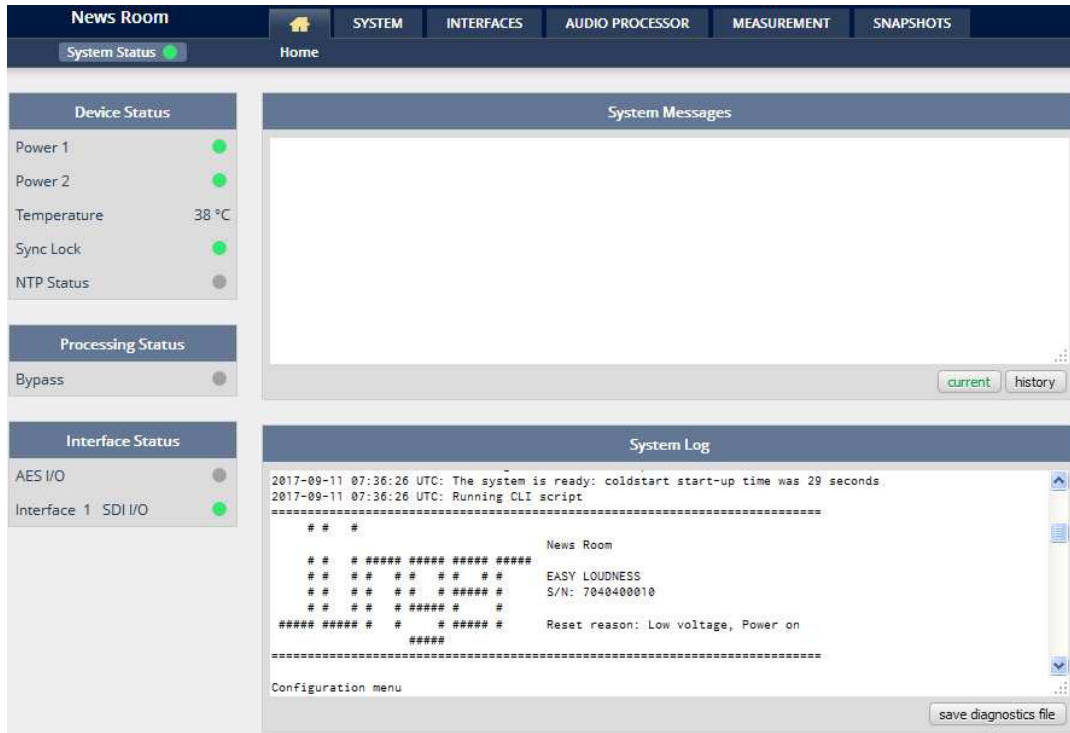

The **System Status** page provides a top level view of the status information available for the device.

- Device Status** Provides the top level status of the **EASY LOUDNESS**. The front panel STATUS LED is connected to this display.

  - Power 1** Status of the first power supply (left hand side of rear panel).
  - Power 2** Status of second power supply (to the right of the first power supply)
  - Temperature** Measured on the surface of the main PCB.
  - Sync Lock** Turns red if the external sync source is lost or unstable.
  - NTP Server Status** Is grey if the NTP server synchronization is turned off. It is green if the clock is synchronized. It turns red if the clock can not be synchronized via one of the NTP servers.
  
- Processing Status**

  - Bypass** Turns red if general Bypass is activated. This can be turned on and off via the X\*AP remote panel only!
  
- Interface Status**

  - AES I/O** Turns red if an AES input that is internally in use (i.e you have routed it to an input of a function block) has detected an error.
  - Interface 1 SDI I/O** Turns red if an error occurs on the SDI interface.
  
- System Messages** [current / history]  
Displays a list of messages produced by the system controller.
  
- System Log** The system controller activities will be logged. This log information may be downloaded from the device and sent to Junger Audio. In case of a problem you can press: **<save diagnostics file>** from here or from: SYSTEM > Admin > Diagnostics.



## Setup GUI – SYSTEM – Overview

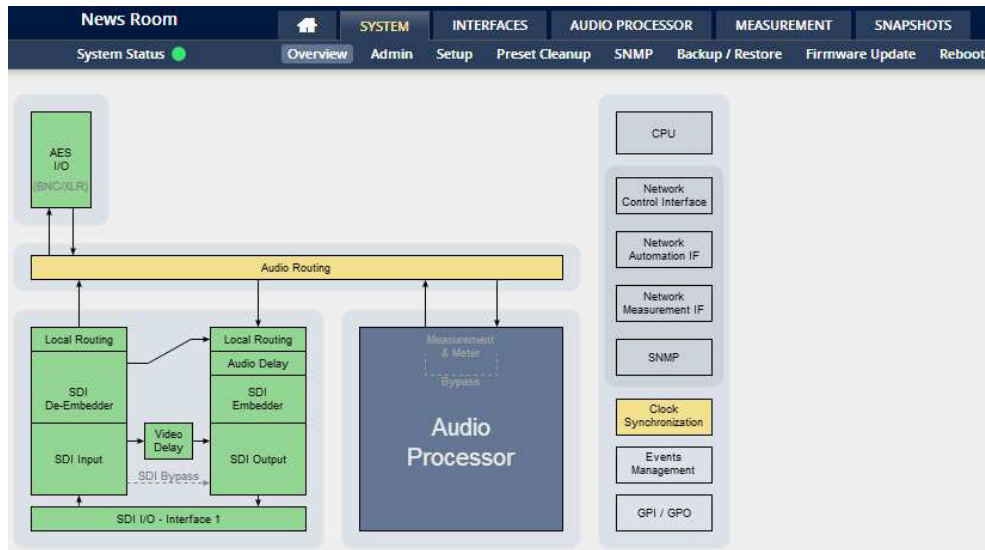

The graphical overview shows the main building blocks of the device including the options installed, in this example a SDI interface is placed into the interface slot (see rear view).

You may click on the boxes and the respective setup page will open. The navigation is based on URLs so you may use the **<Back>** navigation button of the browser to return to this page.

## Setup GUI – SYSTEM – Admin

This Device		Network		Device Time	
Serial Number	7040400010	IP Address	<input type="text" value="10.110.96.10"/>	Date (Local)	<input type="text" value="2017-09-11"/>
Name	<input type="text" value="News Room"/>	Netmask	<input type="text" value="255.255.0.0"/>	Time (Local)	<input type="text" value="17:37"/>
Location	<input type="text" value="Rack 7"/>	Gateway	<input type="text" value="10.110.0.1"/>	Date (UTC)	<input type="text" value="2017-09-11"/>
Admin / Contact	<input type="text" value="admin@my.tv"/>			Time (UTC)	<input type="text" value="15:37"/>
	<input type="button" value="apply"/>		<input type="button" value="apply"/>	Get Time from	<input type="text" value="Manual Setting"/>
Graphical User Interface		Transmit Metering Data		Primary NTP Server	<input type="text" value="192.53.103.104"/>
Startup Page View	<input type="text" value="Onair max / Preset min"/>	Enable	<input checked="" type="checkbox"/>	Secondary NTP Server	<input type="text" value="10.110.2.7"/>
Authentication		Service Options		Update Rate (min)	<input type="text" value="30"/>
Enable	<input type="checkbox"/>	Maintenance Interface via RPC	<input checked="" type="checkbox"/>	The NTP server must be an IP address and not a domain name.	
Change Password for	<input type="text" value="admin"/>	Telnet Server	<input type="checkbox"/>	For external NTP servers, the Network Gateway must be correctly configured.	
Password	<input type="text"/>	Diagnostics			
Repeat	<input type="text"/>	<input type="button" value="save diagnostics file"/>			
	<input type="button" value="apply"/>				

<b>This Device</b>	Input fields for information used by higher level services.
<b>Serial Number</b>	The electronic serial number. It is printed on a label at the rear of the device.
<b>Name</b>	Give the device a meaningful name that may be used by name services and SNMP management.
<b>Location</b>	The place where the <b>EASY LOUDNESS</b> is located.
<b>Admin / Contact</b>	E-mail address of a person in charge. Could be used by an SNMP manager to notify that person.
<b>Graphical User Interface</b>	[Onair max / Preset max, Onair max / Preset min, Onair min / Preset max, Last Used]
<b>Startup Page View</b>	Defines the appearance of the parameter panes in the ON AIR vs. the PRESETS area (which one will be visible).
<b>Authentication</b>	To prevent non-authorized people from changing <b>EASY LOUDNESS</b> settings the administrator may assign passwords for either the admin and/or an operator. While the admin is allowed to set everything, an operator is just allowed to load presets. Parameters will be reset if the operator attempted to change it.
<b>Enable</b>	[ON / OFF] The administrator may turn authentication OFF.
<b>Change Password for</b>	[admin / operator] Select which password you will set / change.
<b>Password</b>	Type in a password Default passwords are: admin (for admin) and operator (for operator).
<b>Repeat</b>	Repeat that password

**Important Note!** The authentication may be enabled / disabled from the **console** interface (see page 8 "1: Manage Password") via USB connection, but also via Telnet! If you have higher security demands you should turn the Telnet server off. Authentication will be turned off and passwords will be reset if one initializes the device to factory default (see Reboot - page 19, INIT/RESET rear button - page 4).

If there was an authentication failure, the **admin** will be notified about such conditions at the next proper login. The pop up appears for each login that has failed. It shows the IP address of the device that caused the authentication failure.



After a correct login the status "who" (e.g. admin) and a **<Log Out>** button are available from the GUI in the upper right corner:

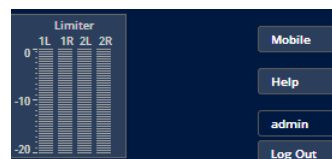

<b>Network</b>	IP address setup, see above: getting started – IP setup of the <b>EASY LOUDNESS – via web browser</b>
<b>IP Address</b>	A proper address for your network – default [10.110.xxx.yyy]
<b>Netmask</b>	The net mask of your network – default [255.255.0.0]
<b>Gateway</b>	The optional gateway address – default [0.0.0.0]
<b>Transmit Metering Data</b>	[OFF / ON]
<b>Enable</b>	Metering data will be streamed via UDP protocol. In order not to receive such data by external applications you may disable it.



## Service Options

- Maintenance Interface via RPC** [OFF / ON]  
For administrative use to enable communication with factory tools.
- Telnet Server** [ON / OFF]  
Enables a telnet server to connect to the console interface via IP port 21.

## Diagnostics

- <save diagnostics file>** Pressing this soft button will start the assembly of a diagnostics file. The file will be presented in XML format for download. If you experience unexpected behavior of the device you may be asked by the Junger service team to send such file by e-mail for analysis.

## Device Time

Allows you to set the device clock. At the factory it will be set to UTC (Coordinated Universal Time).

- Date (Local)** If you click into the **Date (local)** input field, a calendar tool: appears to select month and year.
- Time (Local)** If you click into the **Time (local)** input field, you will be able to set the device time.
- Date (UTC)** Similar as above for local date setting.
- Time (UTC)** Similar as above for local time setting.
- Get Time from** [Manual Setting / Browser / NTP Server]  
If set to **NTP Server** the D\*AP4 will look for the below servers to synchronize the internal clock.
- Primary NTP Server** [5.9.110.236] default set to a publicly accessible NTP server via internet.
- Secondary NTP Server** [10.110.2.7] default set to an internal NTP server from Junger Audio. This is used for device testing and may be overwritten at any time.
- Update Rate (min)** You can set the time interval to update via an NTP server

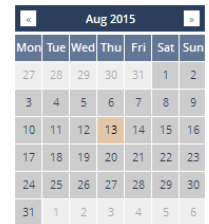
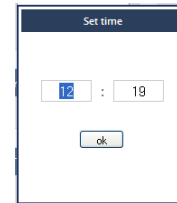

**Important Note!** If it is impossible to synchronize the internal clock to one of the two NTP servers an SNMP "ntpStatusTrap" will be issued by the SNMP agent (if enabled SYSTEM > SNMP > Enable = ON).

- Update Rate (min)** [1 ... 1440]  
Interval of synchronizing the internal clock of the D\*AP4.

Setup GUI – SYSTEM – Setup

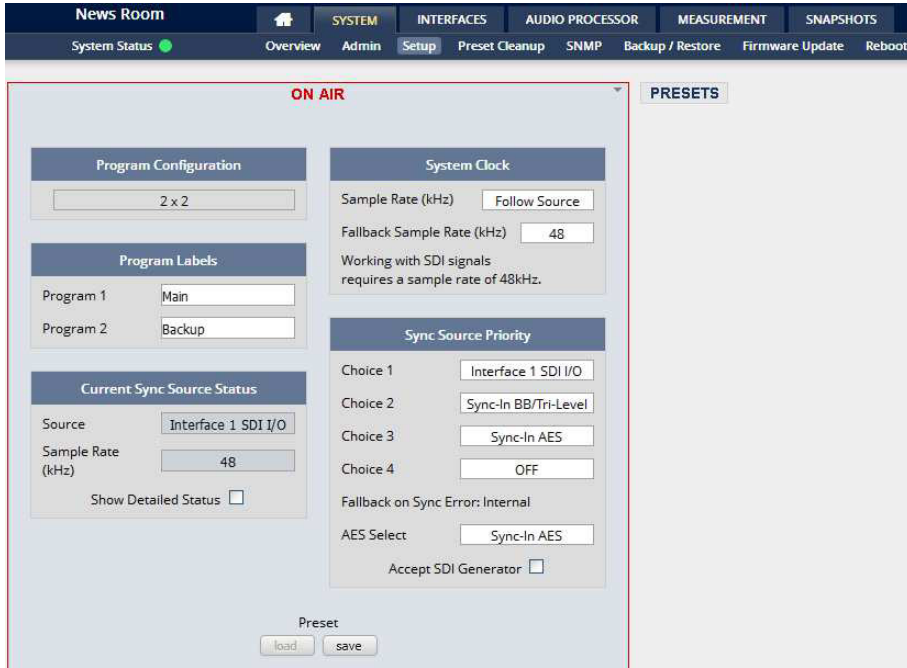

**Program Configuration**

[2 x 2]

Shows the program configuration (two times two channels). This is also the default configuration of the audio processing blocks.

**Program Labels**

**Program 1**

Each of the two possible programs has a name that will be used

**Program 2**

Label as a reference for the display of parameters and their setup.

You may edit the default names.

**Current Sync Source Status**

shows the status of the 5 tier sync priority circuit

**Source**

Display of the active sync source.

**Sample Rate**

The measured sample rate.

**Show detailed status**

[ON / OFF]

If you enable that checkbox you will get this information:

**Sync Source Information**

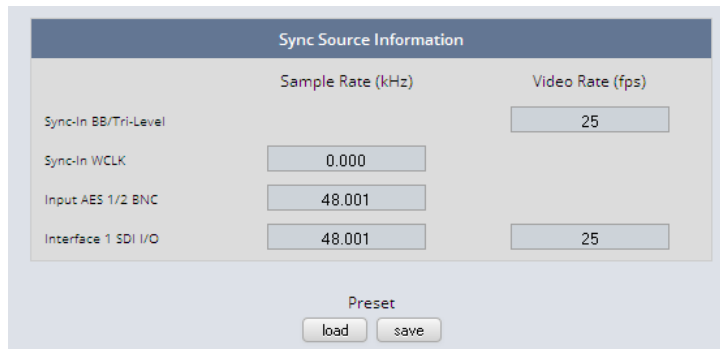

You will get detailed information about the measured rates of possible sync sources

## System Clock

**Sample Rate** [Follow Input / 44.1 / 48 / 88.2 / 96]  
**Fallback Sample Rate** [44.1 / 48 / 88.2 / 96]

## Sync Source Priority

**Choice 1 – 4** [OFF / Internal / Sync-In WCLK / Sync-In AES / Interface 1 (SDI I/O or Dante) / Sync-In Black Burst/Tri-Level]

**Fallback on Sync Error** [Internal]  
 If the selected sync source is not available the next source will be selected. If none of the pre-selected sync sources is available, the source will fall back to the internal clock oscillator.

**AES Select** [Sync-In AES / Input AES 1/2 XLR / Input AES 1/2 BNC]  
 Select from which physical input the AES sync must be taken.

**Accept SDI Generator** [ON / OFF]  
 For rare applications you may use the SDI generator (if an SDI I/O interface is installed) as the sync source. In this case downstream equipment must be synchronized to the **EASY LOUDNESS**. See **INTERFACES > SDI I/O interface > Setup** for details.

**Important note!** It is **not** possible to gen lock the SDI generator. The generator will run on its own internal 27MHz crystal clock.

## Setup GUI – SYSTEM - the **preset concept** in detail

The example above shows the **preset concept** of the **EASY LOUDNESS**. It is a general feature of the device and you will come across it in almost every area. For all relevant settings one set of **ON AIR** parameters and a practically unlimited number of **PRESETS** are available. The count depends on the NV memory space left.

If you want to load parameters from a preset to the **ON AIR** area or save parameters from the **ON AIR** area to a preset, you must press **<load>** or **<save>**:

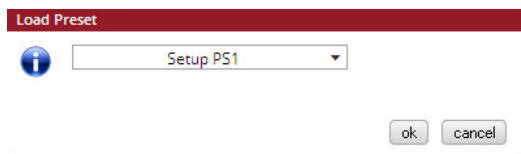

A dialog opens to select the desired preset. If you press **<ok>** the selected action will be executed. If you press the little pencil icon the preset name turns **italic** and you may edit it.

To generate a new preset offline, you must click into the preset name field below the **PRESET** headline:

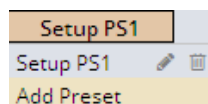

The pull down offers "**Add Preset**". If you select this a new entry to the list will be generated. Clicking on the small trash bin symbol will delete that preset. You may change the default name "Preset x" by clicking the small pencil icon. Now the default name becomes **italic** and you may edit that name.

If you have selected the new preset or one of the existing presets indicated by the name displayed at the top, you may edit the parameter values.

**Important Note!** The presets of the **EASY LOUDNESS** are persistent by nature. You are working directly on the preset memory, i.e. you need not worry about storing such presets. The **EASY LOUDNESS** does it for you. On the other hand you must be aware that you are **overwriting the actual preset settings!** If you want to keep original values (e.g. from a factory preset) you must simply **copy** the content of an existing one to the clip board, add a new preset, name it differently and **paste** the clip board to it.

At the bottom of the **PRESET** part you will find the soft buttons to **<copy>** the content of that preset to the clip board or to **<paste>** the content of the clip board into another preset which you have selected before pasting.

You may also **<export>** or **<import>** the preset content to / from a file.

Setup GUI – SYSTEM – Preset Cleanup

It is sometimes desirable to delete presets which are used by multiple events without stepping through all processing blocks and deleting the respective presets one by one. This pane offers you a tool to remove presets via a central access point:

Preset Name	Type	Preset Block	Last Modified	Linked to Event	Select
AES to SDI		Routing - Routing	2017-09-06 08:34:15	Yes	<input type="checkbox"/>
Band Pass	Stereo	Audio Processor - Programs - Input	2014-05-26 11:47:21	No	<input type="checkbox"/>
BNC SRC OFF		Interfaces - AES I/O	2015-04-02 11:58:26	No	<input type="checkbox"/>
BNC SRC ON		Interfaces - AES I/O	2015-04-02 11:57:59	No	<input type="checkbox"/>
BNC SRC ON		Interfaces - AES I/O	2015-04-02 11:59:29	No	<input type="checkbox"/>
Bypass		Routing - Routing	2014-05-22 14:55:07	No	<input type="checkbox"/>
CLEAR		Interfaces - AES I/O	2014-05-27 14:36:57	No	<input type="checkbox"/>
CLEAR	Stereo	Audio Processor - Programs - Input	2014-05-26 11:47:21	No	<input type="checkbox"/>
CLEAR	Stereo	Audio Processor - Programs - Level Magic	2017-09-06 08:34:05	No	<input type="checkbox"/>
CLEAR	Stereo	Audio Processor - Programs - Output	2015-04-02 11:48:39	No	<input type="checkbox"/>
CLEAR		Routing - Routing	2017-07-07 13:27:21	No	<input type="checkbox"/>
CLEAR		Audio Processor - Programs - Fail Over	2014-05-22 14:52:13	No	<input type="checkbox"/>
Default	Stereo	Audio Processor - Programs - Input	2017-09-06 08:33:54	No	<input type="checkbox"/>
Default	Stereo	Audio Processor - Programs - Level Magic	2017-09-06 08:34:07	Yes	<input type="checkbox"/>

You can sort the table by pressing on one of the column headlines. You can qualify your selection by the "Type" selector and / or the "Preset Block", "Linked to Event", "Last Modified" column headlines. The pull-down lists allow you to reduce the number of presets displayed:

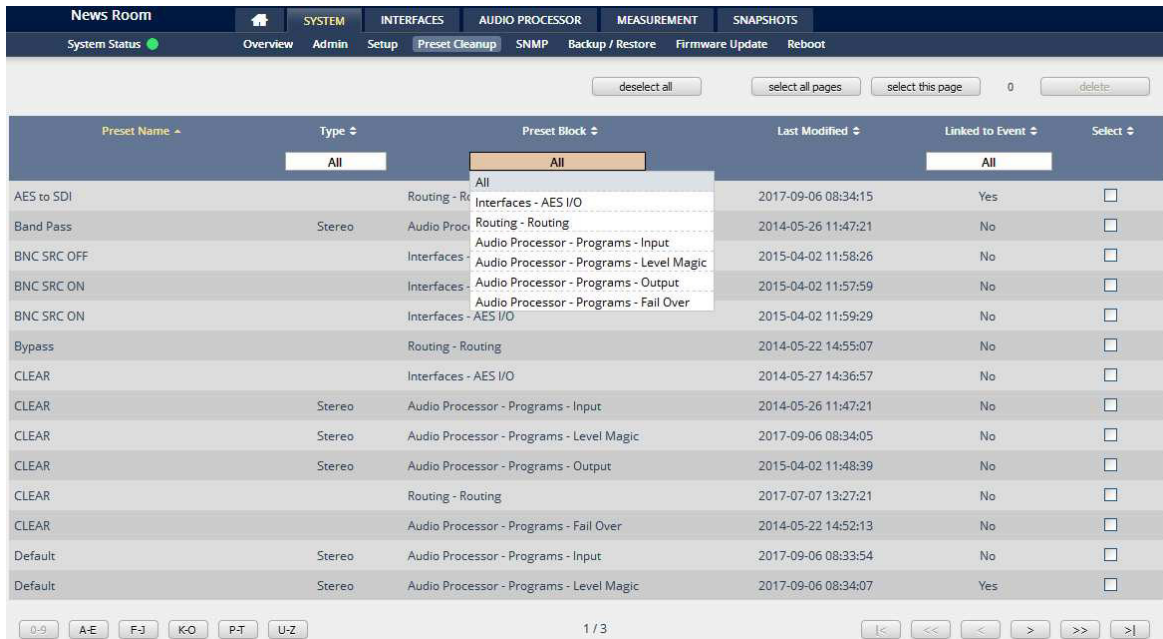

The soft buttons at the bottom left hand side may also be used to search through the table by sorting it by the first letter or leading number. The arrow buttons at the bottom right hand side can be used to scroll through the table if the selection is too big for one page:



A selection is made by clicking on a line to activate the check box. Once you have made your selection (highlighted lines) you can press the **<delete>** soft button to execute the process. This will remove the selected presets permanently from the device.

Setup GUI – SYSTEM – **SNMP**

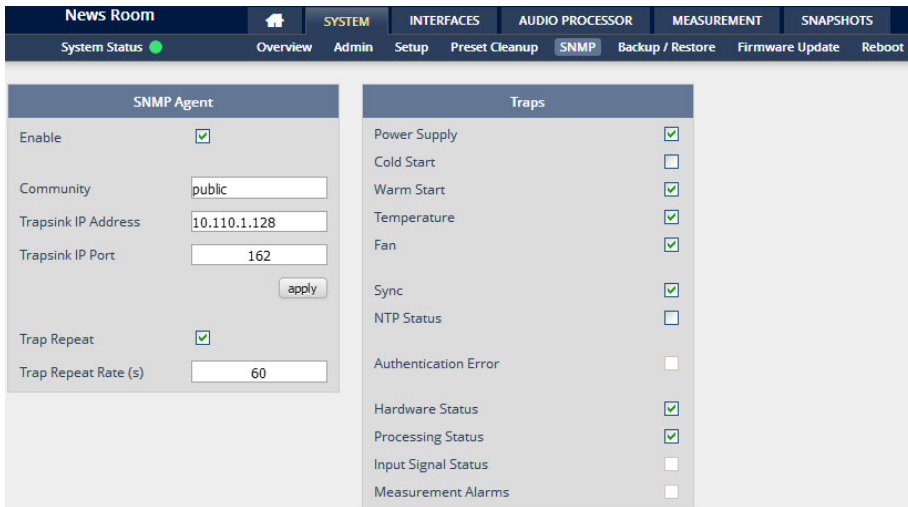

This pane is meant for basic settings of the **SNMP Agent** of the device. If you are not familiar with the use of SNMP protocol for system monitoring you should not enable the SNMP agent.

Setup GUI – SYSTEM – **Backup / Restore**

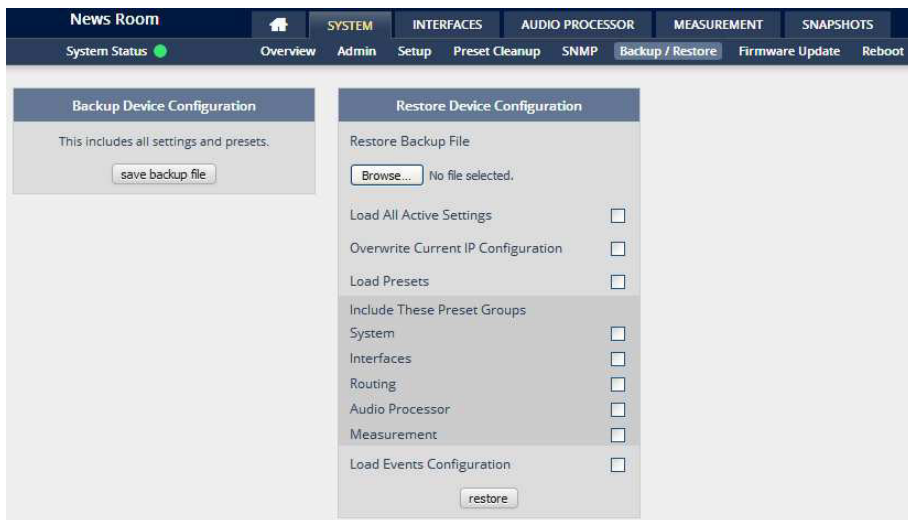

Here you can **backup** the complete **device** and **restore** parts or all of it. If you press **<backup>** the device controller will collect all necessary data and assemble it to an XML file. Finally you will get a pop up message:

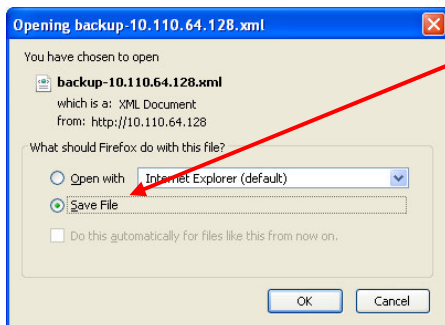

You must select: **<Save File>**.  
After pressing **<OK>**, the system file dialog opens:

Select a folder and alter that default file name if needed.

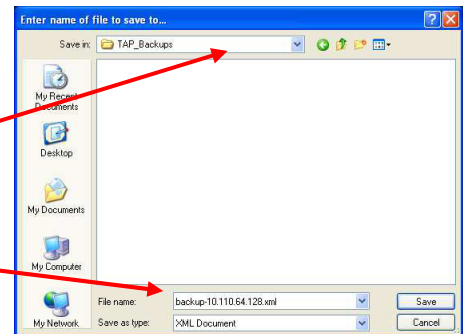

Similar applies to the restore process. You must select the desired backup file which you want to restore and check the necessary option(s) under "Restore Device Configuration".



## Setup GUI – SYSTEM – Firmware Update

The files to update the **EASY LOUDNESS** will be available in **ZIP** format. You must unpack them to your PC in order to use them for the update procedure. Here an example path name from the ZIP file:  
 junger\_dap4\_mei\_firmware/base\_unit\_image

The folder /base\_unit\_image contains an image file for the **EASY LOUDNESS** core system in the format (example):  
 "rel\_dap4-me\_i\_3\_0\_2-25852.img". The other folders contain update files for components, like the optional interface boards in the format: "rsdi150\_v51.sdi" or for the **X\*AP RM1** remote panel in the format: xap\_125105.img.

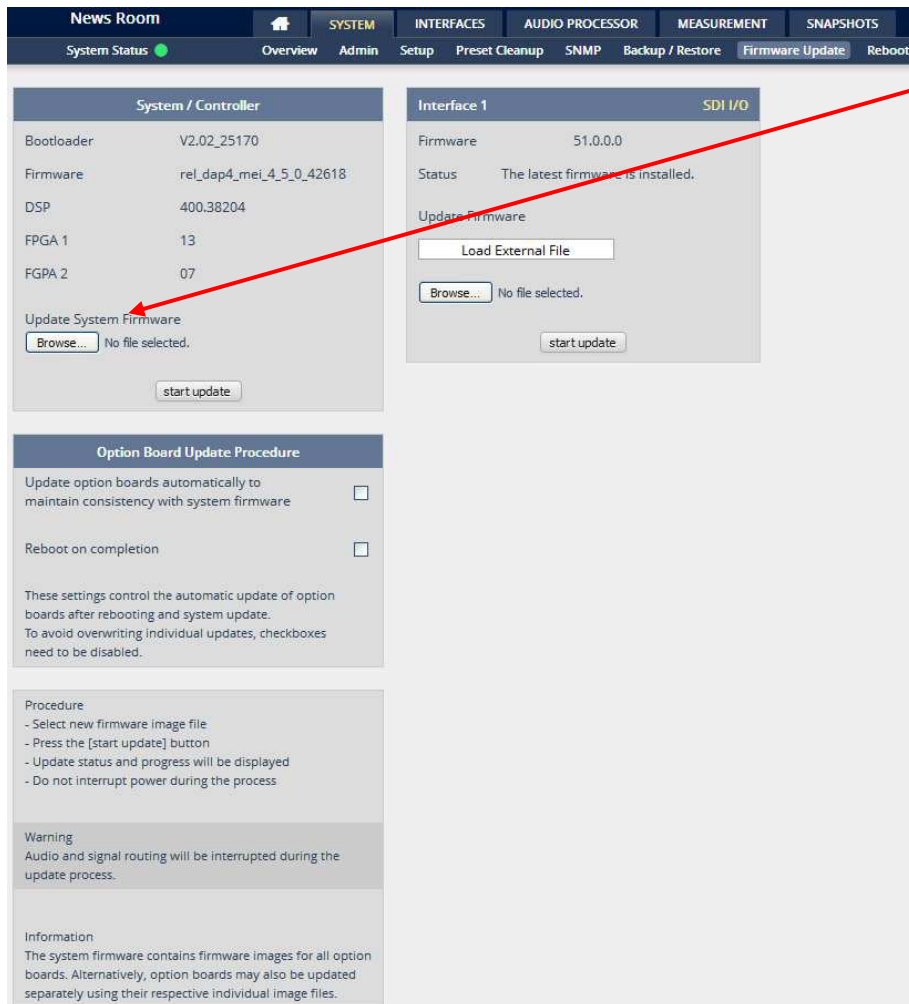

To update the **EASY LOUDNESS**, you must **<Browse ...>** to find the respective firmware file (which you have unzipped before) and press **<start update>**. After finishing the procedure the device will automatically reboot.

You may also update the firmware of an installed interface (SDI or DANTE) in slot 1.

**Important Note!** After the update of the latest firmware image you must observe the **Status** messages displayed in the middle below the firmware version of Interfaces x. If it indicates that you don't have the latest firmware installed, you should select the respective file(s) via the drop down box and press the **<start update>** soft button afterwards. But you can also upload an external file in case you need a specialized version for any reason that is not contained in the uploaded firmware image. Same applies to all interface boards.

In particular, if you have activated automatic update of option boards, you must secure power connection during the update procedure. There is a potential risk of crashing the **Dante** board firmware when you lose power during the module update (see interface description how to recover).

Setup GUI – SYSTEM – Reboot

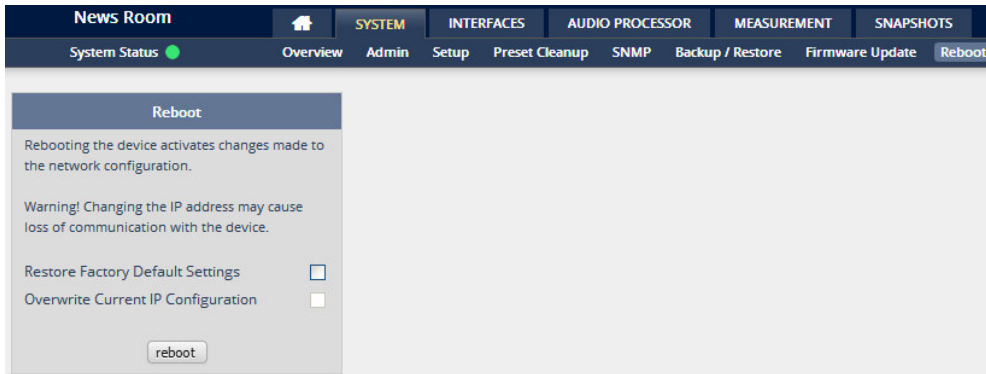

**Restore Factory defaults**

will clean up the parameter and preset memory and will initialize all parameters to their factory default values and will reset passwords and turn authentication off.

**Overwrite Current IP Configuration**

You may exclude the current IP settings from this process to keep your existing settings.

Setup GUI – INTERFACES

If you press one of the **INTERFACES** tabs, you will get a pop-up that gives you a warning:

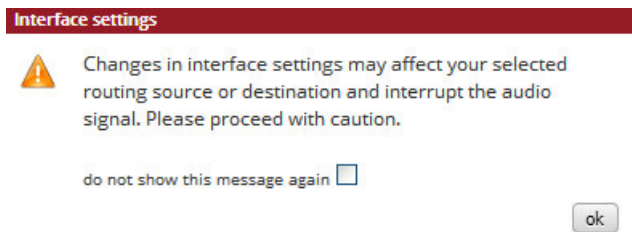

The EASY LOUDNESS is pre-configured to make life easy for you as the user / operator. I.e. you should be careful when changing settings here because it may affect the audio routing in the background. We would kindly ask you not to change interface settings here, if you are not familiar with the results.

Setup GUI – INTERFACES – AES I/O

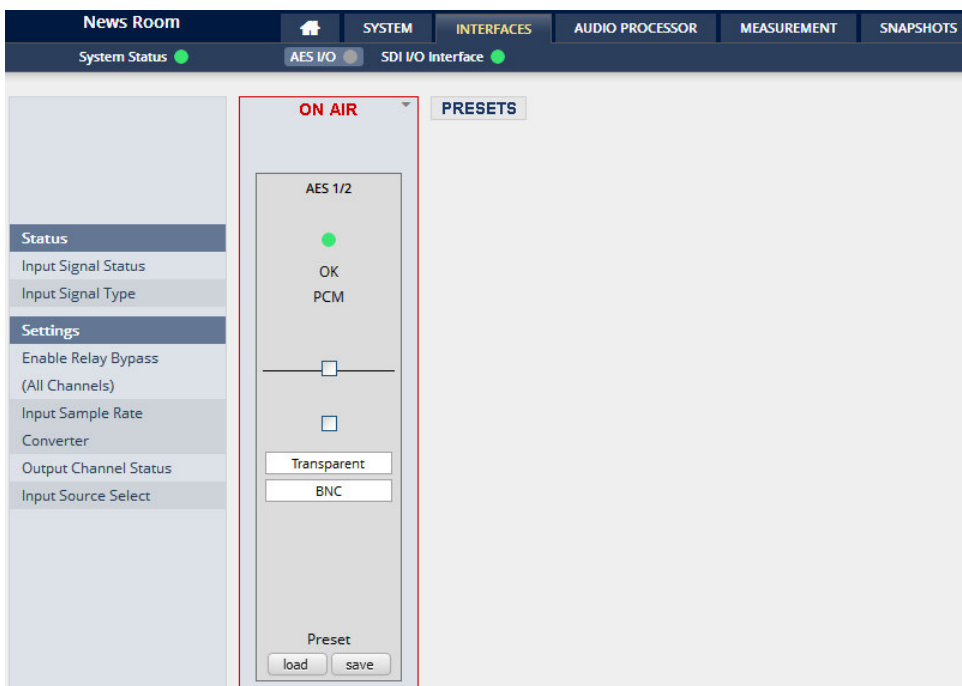



<b>Status</b>	[green / red / yellow] the soft LED represents the signal status.							
<b>Input Signal Status</b>	[OK / Fail] Fail = no carrier, unlock, cranky [too much jitter]							
<b>Input Signal Type</b>	[Mute / PCM / Non PCM] The <b>Non PCM</b> (e.g. Dolby encoded signal) status will be retrieved from a logical combination of the Validity flag and the channel status.  If the input is not assigned, its status will not be incorporated into the System Status (see upper left hand side above).							
<b>Settings</b>								
<b>Enable Relay Bypass</b>	[ON / OFF] For fail save operation bypass relays are provided to connect AES IN / OUT in case of a power failure. One may enable such relay manually here.							
<b>Input Sample Rate Converter</b>	[ON / OFF] For asynchronous sources it is possible to turn an <b>SRC</b> on. If an <b>SRC</b> is turned on and the input status becomes <b>Non-PCM</b> , the <b>SCR</b> will be turned OFF automatically in order to maintain the original data structure of the encoded bit stream (e.g. Dolby E).							
<b>Output Channel Status</b>	[Transparent / Prof PCM / Prof Non-PCM / Cons PCM / Cons Non-PCM] The channel status can either be transparent from the input source of the <b>EASY LOUDNESS</b> or may be overwritten.	<table border="1"> <tr><td>Transparent</td></tr> <tr><td>Prof PCM</td></tr> <tr><td>Prof Non-PCM</td></tr> <tr><td>Cons PCM</td></tr> <tr><td>Cons Non-PCM</td></tr> <tr><td>Transparent</td></tr> </table>	Transparent	Prof PCM	Prof Non-PCM	Cons PCM	Cons Non-PCM	Transparent
Transparent								
Prof PCM								
Prof Non-PCM								
Cons PCM								
Cons Non-PCM								
Transparent								
<b>Input Source Select</b>	[BNC / XLR] You must select here which input is in use. (AES3id = BNC or AES3 = XLR).							

**Important note!** The AES relay bypass circuit of the AES I/Os may be deactivated inside the **EASY LOUDNESS**. You must open the cover plate from the **EASY LOUDNESS** unit and locate the red jumpers shown in the schematic below:

**AES 1/2 on the main PCB**

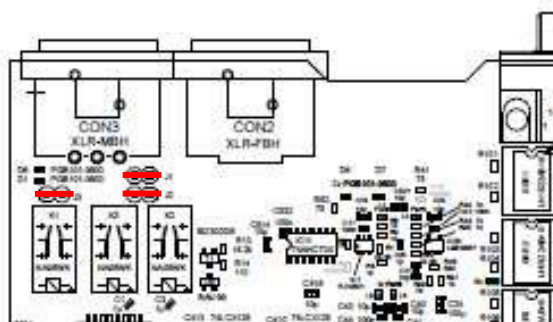

You must remove the jumpers to de-activate the AES I/O relay power fail circuit.

Set up GUI – INTERFACES – SDI I/O interface – Overview

If the **EASY LOUDNESS** is equipped with an optional **SDI** interface the following settings will be available. This pane has five sub panes imbedded:

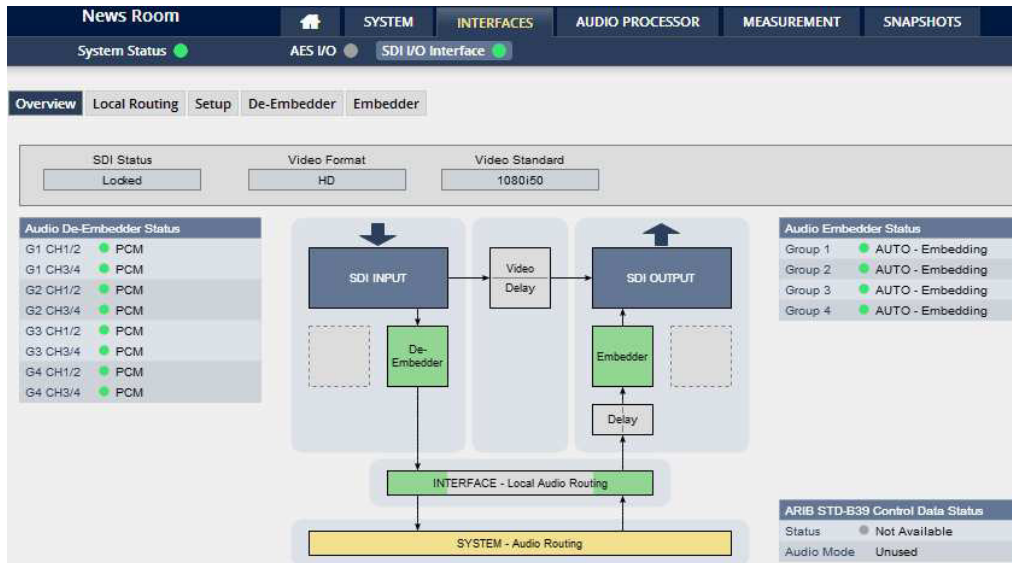

The overview pane shows all relevant information of that interface:

**SDI Status** [Locked / Unlocked]

**Video Format** [SD / HD /3G / N/A]

**Video Standard** [current decoded standard (e.g. 1080i50) / No SDI Lock]

**Audio De-Embedder Status** [PCM / Dolby E / Dolby Digital / Dolby Digital Plus / MPEG-4 HE AAC / MPEG-4 AAC / N/A]

**Audio Embedder Status** [AUTO – Embedding / AUTO – Replace Audio / OFF / Delete]

**Group 1 – 4** The embedding process distinguishes between 4 different modes for each group independently:

- AUTO - Embedding** – a new group will be built
- AUTO – Replace Audio** – the structure of the group from the input is kept and the audio content is simply replaced
- Delete** – the group from the input is deleted
- OFF** – the embedder from that group is turned off

**ARIB STD-B39 Control Data Status** Meta information standard

**Status** [Available / Not Available]

**Audio Mode** See **ARIB** Japanese standard "Structure of Inter-Stationary Control Data Conveyed by Ancillary Data Packets"  
[http://www.arib.or.jp/english/html/overview/doc/2-STD-B39v1\\_2.pdf](http://www.arib.or.jp/english/html/overview/doc/2-STD-B39v1_2.pdf)

## Set up GUI – INTERFACES – SDI I/O interface – Local Routing

The SDI interface comes with a local routing matrix to shuffle audio signals from and to the system (device) and from and to the physical de-embedders / embedders.

The example below shows a routing that sends signals 1:1 from the physical de-embedders [INTERFACE – SDI IN: SDI IN G1 CH1 ... SDI IN G4 CH4] to the device inputs [SYSTEM – SDI De-Embedder: DEM1 ... DEM16] and the signals from the device

[SYSTEM – SDI Embedder: EMB 1 ... EMB16] are sent to physical Embedders [INTERFACE - SDI OUT:

SDI OUT G1 CH1 ... SDI OUT G4 CH4]:

The screenshot displays the 'Local Routing' configuration window. At the top, there are navigation tabs: Overview, Local Routing (selected), Setup, De-Embedder, and Embedder. Below these are 'ON AIR' and 'PRESETS' buttons. A 'Preset' section contains 'load' and 'save' buttons. A 'Channel Linking' section has a 'Mono' button. The main area is a routing matrix with two columns: 'INTERFACE - SDI OUT' and 'SYSTEM - SDI De-Embedder'. The matrix shows a 1:1 routing from SDI IN G1 CH1 to DEM 1, SDI IN G1 CH2 to DEM 2, SDI IN G1 CH3 to DEM 3, SDI IN G1 CH4 to DEM 4, SDI IN G2 CH1 to DEM 5, SDI IN G2 CH2 to DEM 6, SDI IN G2 CH3 to DEM 7, SDI IN G2 CH4 to DEM 8, SDI IN G3 CH1 to DEM 9, SDI IN G3 CH2 to DEM 10, SDI IN G3 CH3 to DEM 11, SDI IN G3 CH4 to DEM 12, SDI IN G4 CH1 to DEM 13, SDI IN G4 CH2 to DEM 14, SDI IN G4 CH3 to DEM 15, and SDI IN G4 CH4 to DEM 16. Below the matrix, there is a list of 'SYSTEM - SDI Embedder' (EMB 1 to EMB 16) with corresponding DSP (DSP 1 to DSP 4) and IF1 (IF1 5 to IF1 16) labels.

**Important Note!** The matrix display is a generic view generated by the SDI interface.

For the **EASY LOUDNESS** application the SYSTEM labels are translated in pairs:

DEM 1/2 to SDI 1/2 ... DEM 15/16 to SDI 15/16

EMB 1/2 to SDI 1/2 ... EMB 15/16 to SDI 15/16

If you must shuffle SDI signals to meet a certain output signal assignment you can do it with the above matrix. E.g. you may shuffle SDI IN G2 CH1/2 to SDI OUT G4 CH3/4.

You must use the scroll bar to navigate through the matrix. In the upper left hand corner you can select between the **ON AIR** and the **PRESETS** view of the matrix. On the **ON AIR** page you will also see the bluish device signal labels (e.g **DSP x**).

**Channel Linking** [mono / stereo]  
 You can decide if the routing must be performed in mono or stereo mode (where adjacent odd/even channels are routed at once).

You may select cross points by hovering with the mouse over the little squares and selecting / deselecting cross points with a left mouse button click.

**Mouse over** Color codes of cross points:

- dark blue** Possible new cross point.
- orange** You are about to reconnect a cross point.
- grey** Cross point is not allowed (i.e. routing will cause a loop and will not therefore be performed) or dedicated input is not activated.
- red** You are about to disable a cross point.

An animated signal flow  will help you when navigating through the matrix.

Set up GUI – INTERFACES – SDI I/O interface – **Setup**

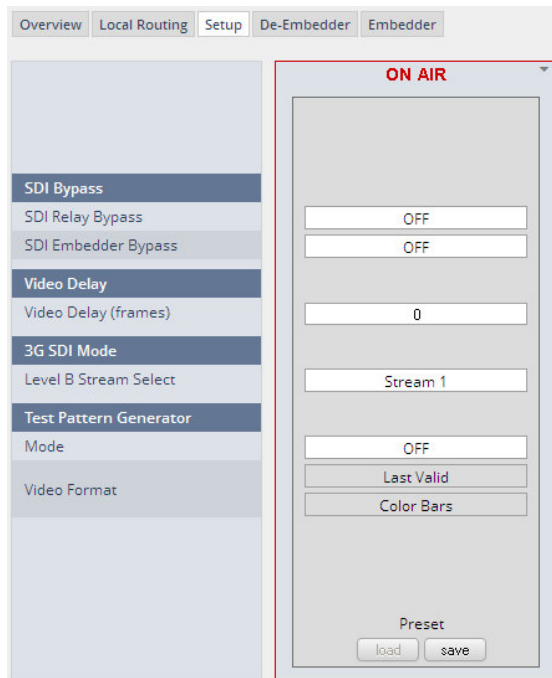

**SDI Bypass**

**SDI Relay Bypass** Will deactivate the **Bypass Relay**. It provides a shortcut from **SDI-IN** to **SDI-OUT1** and disconnects the de-embedder from the SDI input. This relay also serves as a **fail bypass** if the power is off. This feature maintains the SDI signal for downstream equipment.

**SDI Embedder Bypass** Will pass the embedded audio data from the de-embedder to the embedder 1:1. This function preserves the original ancillary data structure.

**Video Delay**

**Video Delay (frames)** [0 ... 15]  
 For compensation of any kind of audio processing delay within the chain of devices you may use a **Video Delay**. Position "0" turns off the delay function.

**3G SDI Mode**

**Level B Stream Select** A 3G-SDI signal may have two HD sub streams (e.g. for 3-D TV), AKN as 3G-B standard. Select between stream 1 or 2 for embedded audio. See SMPTE 425M for details.

**Test Pattern Generator**

The interface offers a test generator to either check downstream connections during installation or for use in case of an input fail but you may also use it to move 16 independent audio channels over a single coax cable from point to point.

**Mode** [OFF / AUTO (Input Loss) / Always ON]

**Video Format** [Last valid / one of the defined SD / HD 3G formats (see specs)]  
 [Color Bars / Black Frame]

## Set up GUI – INTERFACES – SDI I/O interface – De-Embedder

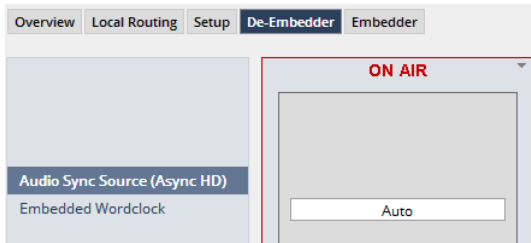

### Audio Sync Source (Async HD)

The HD SDI standard allows for asynchronous audio. This is critical if you have decided to synchronize the device on such signal. Here you find a solution. You may either use the embedded word clock or the SDI carrier itself as a reference.

### Embedded Word Clock

[Auto / De-Embedder CH1 (DEM 1) / OFF]

OFF = synchronized to the SDI carrier.

Auto = In case of asynchronous audio it is synchronized automatically to the SDI carrier.

DEM1= From de-embedder group 1 channel 1.

## Set up GUI – INTERFACES – SDI I/O interface – Embedder

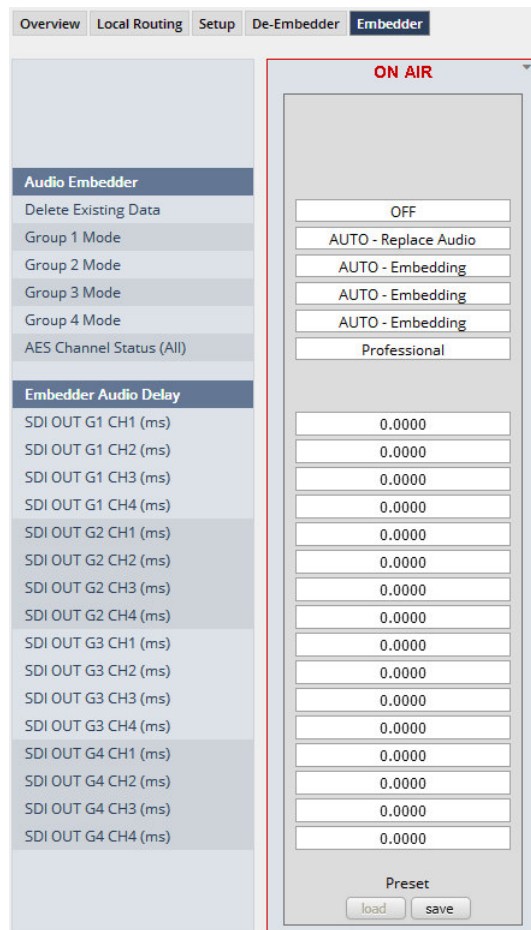

### Audio Embedder

Here you set the general functions of the SDI embedder

#### Delete Existing Data

[OFF / ALL – New HANC Structure]  
Will erase all existing audio structures and generates a new structure from scratch.

#### Group 1 – 4 Mode

[OFF / AUTO – Embedding / AUTO – Replace Audio / Delete]  
OFF – will turn the embedder off. I.e. existing signals from the SDI input are passed through.  
AUTO – Embedding will simply exchange the audio for that group. If a signal path from the device is routed to the embedder, it will be embedded. If no signal is routed from the device, the embedded signal from the SDI input will be used.  
AUTO – Replace Audio will replace the data structure of that group and will embed audio from the device if a signal is routed to it. If no signal is routed from the device, the embedded signal from the SDI input will be used.

See SDI I/O Interface > Overview for a view of the signals available from the de-embedder and the status of the four embedders.

<b>AES Channel Status (All)</b>	[Transparent / Professional]
For the option "Professional" these values are used:	
Format:	Professional
Audio Mode:	[Audio / Non Audio]
Emphasis:	None
Freq. Mode:	Locked
Sample Freq.:	48kHz
Channel Mode:	Not Indicated
User Bits:	None
Auxiliary Bits:	24Bit
Audio Word Length:	Not indicated

**Important note!** If you generate a new AES channel status, the **Audio Mode** will be automatically set to **Non Audio** (AKA "other") for both channels of an adjacent pair (1/2, 3/4 .....) if encode audio is detected that carries a Dolby E stream for example.

<b>Embedder Audio Delay</b>	Each embedder signal may be delayed independently. This may be useful for Lips Sync alignment if a video delay is used.
<b>SDI OUT G1 CH1 (ms)</b>	[0.0000 ... 340.000]
...	
<b>SDI OUT G4 CH16 (ms)</b>	[0.0000 ... 340.000]

Set up GUI – INTERFACES – Dante I/O Interface – **Status**

The **Dante** interface connects an **EASY LOUDNESS** to an audio over IP (AoIP) network. Junger Audio has committed itself to the quasi industry standard **Dante** developed by **Audinate**:



"Based on industry standards, Audinate created **Dante**, an uncompressed, multi-channel digital media networking technology, with near-zero latency and synchronization ... One cable does it all.

**Dante** does away with heavy, expensive analog or multicore cabling, replacing it with low-cost, easily-available CAT5e, CAT6, or fiber optic cable for a simple, lightweight, and economical solution. **Dante** integrates media and control for your entire system over a single, standard IP network."

The network infrastructure for **Audio over IP** must be able to handle the **IP multicast**. So it needs a bit of care when it comes to network gear. The recommendation is to separate the control network from the audio network.

For details pls. refer to the Audinate web-site: <https://www.audinate.com>. Here you will find many useful application videos and FAQs.

To configure such an audio network you need the **DanteController** software. You can download it from the **Audinate** website. People who want to interface a PC or MAC to such an audio network can use the **Virtual Soundcard** or even more sophisticated the **Via**, an applications software from **Audinate**. The **Virtual Soundcard** provides audio drivers to connect with common audio tools while **Via** allows you to connect network audio resources with PC audio resources like analog line / Mic / USB-Audio / even applications (Skype, youtube you name it) directly.

We highly recommend reading the **Audinate** documents to understand how to set-up and operate a real-time **AoIP** network.

Looking at the rear panel the RJ45 connector, the primary is the on the left while the second connector acts either as a redundant or as a switch port. Both RJ45s have built in LEDs. The left one shows network activities (flashing green) while the right one indicates the interface speed, with **green=1Gbit/s** and **off=100MBit/s**.



Below is the Status page of the **DANTE** interface board:

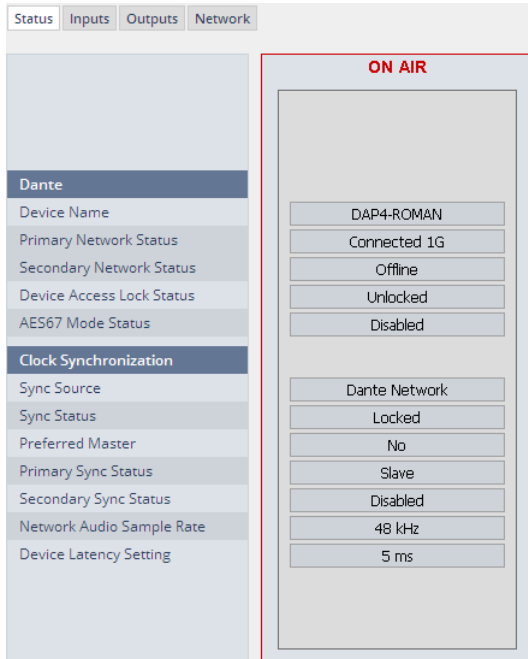

## Dante

**Device Name** The name you gave the interface board via the **DanteController**: Device > Device View > Device Config

**Primary Network Status** [Offline / Connected + bandwidth]

**Secondary Network Status** [Offline / Connected + bandwidth]

**Device Access Lock Status** [Unlocked / Locked]  
See Dante Controller

**AES67 Mode Status** [Diabled / Enabled]  
See Dante Controller to enable it.

## Clock Synchronization

**Sync Source** [Dante Network / DA\*P is Master]  
Here you define the reference clock for this **Dante** module.

**Important Note!** If this parameter is set to "Dante Network", the **EASY LOUDNESS** must be synchronized to the same clock as the network clock master (whoever it is). It **must** be set to "Dante Network" if this module is to become the "Preferred Master" of the network.

**Sync Status** [Unlocked / Locked / Locked-Async]  
The sync source for the **Dante** interface is the **Dante** network. If no network cable is connected the interface is "Unlocked". If it is connected to a network it will be "Locked". If the **EASY LOUDNESS** is set to synchronize to other than the **Dante** interface it will show "Locked-Async".

**Preferred Master** [No / Yes]  
The **Dante** algorithm automatically looks for the best clock master inside the network but one may force a **Dante** module to become the clock master.

**Primary Sync Status** [Slave / Master]

**Network Audio Sample Rate** [44.1 kHz / 48 kHz / 88.2 kHz / 96 kHz]  
Depending on the A\*P device type the sample rate is limited to the device specification.

**Device Latency Setting** [5ms]  
You can allow for a certain transmission latency if you face network problems of any kind.

Set up GUI – INTERFACES – Dante I/O Interface – Inputs

The **DanteController** software gives you an overview of all members of such a **DANTE** network. You can assign channel labels for the inputs (from the network to the device interface). Those labels will automatically appear in the **EASY LOUDNESS** and will be displayed there.

Here is a glimpse of the GUI of the **DanteController**:

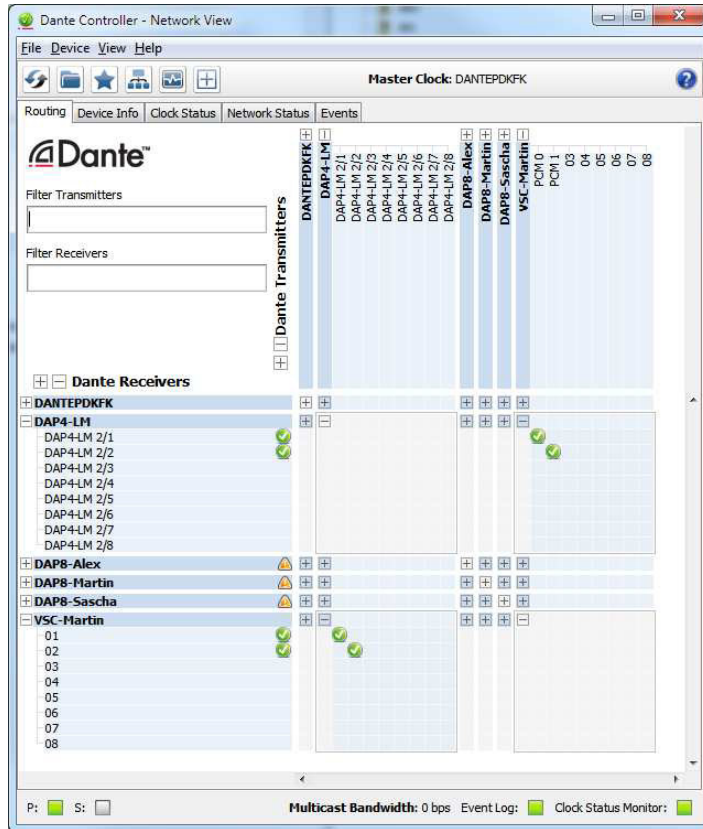

As an example you see here a "DAP4-LM" (name given by the Dante Controller) that has assigned the labels DAP-4 2/1 ... 2/8 for both the inputs and the outputs.

Beside a few more devices on that network, we see the unfolded outputs of a **DanteVirtualSoundcard (VSC)** named "VSC-MARTIN" on the upper right hand side.

The top horizontal area shows the transmitters while the receivers are shown vertically on the left hand side.

The outputs PCM 0 and PCM 1 from the VCS are assigned to the **EASY LOUDNESS** inputs DAP4-LM 2/1 and 2/2 while two outputs from the "DAP4-LM" are assigned to the VSC inputs "01" and "02".

We see the labels assigned by the DanteController software in the "Channel" column:

Status Inputs Outputs Network			
Inputs	Channel	Connected	Status
DTIN 1 <span style="color: green;">●</span> PCM	DAP4-LM 2/1	PCM 0 @ VSC-Martin	Connected (Unicast)
DTIN 2 <span style="color: green;">●</span> PCM	DAP4-LM 2/2	PCM 1 @ VSC-Martin	Connected (Unicast)
DTIN 3 <span style="color: green;">●</span> PCM	DAP4-LM 2/3	no subscription	No Subscription
DTIN 4 <span style="color: green;">●</span> PCM	DAP4-LM 2/4	no subscription	No Subscription
DTIN 5 <span style="color: green;">●</span> PCM	DAP4-LM 2/5	no subscription	No Subscription
DTIN 6 <span style="color: green;">●</span> PCM	DAP4-LM 2/6	no subscription	No Subscription
DTIN 7 <span style="color: green;">●</span> PCM	DAP4-LM 2/7	no subscription	No Subscription
DTIN 8 <span style="color: green;">●</span> PCM	DAP4-LM 2/8	no subscription	No Subscription

**Inputs**

Eight inputs are pre-defined for the **DANTE** interface installed in an **EASY LOUDNESS**. They are organized in pairs and the input status is shown by soft LEDs (green = PCM audio / yellow = non audio/ grey no audio).



**Channel** The labels assigned to that channel by the **DanteController**

**Connected** The source of the audio signal.

**Status** [No Subscription / Subscription Unresolved / Wait / Naming Problem / Loopback / Idle / Subscription in Progress / Connected (Unicast) / Connected (Multicast) / Manual Config / Format Problem / QoS Problem / Latency Problem / Clock Domain Problem / Link Down / Fail / Unknown]  
The DANTE module provides very detailed status information. In regular operation one will not see much of it.

## Set up GUI – INTERFACES – Dante I/O Interface – **Outputs**

Outputs	Channel	Channel Label
DTOUT 1	01	DAP4-LM 2/1
DTOUT 2	02	DAP4-LM 2/2
DTOUT 3	03	DAP4-LM 2/3
DTOUT 4	04	DAP4-LM 2/4
DTOUT 5	05	DAP4-LM 2/5
DTOUT 6	06	DAP4-LM 2/6
DTOUT 7	07	DAP4-LM 2/7
DTOUT 8	08	DAP4-LM 2/8

**Outputs** The signals from the **DANTE** board to the network. They will also appear in the device **ROUTING** section.

**Channel** Numeric count of the channels.

**Channel Label** Up to 16 labels can be configured for each stream from the interface to the network. This allows configuring multi layer routing.

## Set up GUI – INTERFACES – Dante I/O Interface – **Network**

**Dante Redundancy** The DANTE interface allows redundant network operation. Pls. refer to manufacturer's documentations of your Ethernet equipment on supported switching configuration and redundant operation.

<b>Mode</b>	[Switched / Redundant]
	Redundant – The interface will duplicate the audio traffic to both Ethernet ports.
	Switched – The second port behaves like a standard switch port allowing daisy-chaining through the interface. I.e. IP configuration is only available for Redundant mode.

**Important Note!** When set to switched mode, do **not** connect both ports to the same network (same Ethernet switch) if it does not support STP (Spanning Tree Protocol). This is the case for most of the off-the-shelf (office) switches. Doing so will cause a race condition where IP packets are circling around from the external switch to the second **Dante** (switch) port and back via the first port. This will tear down your network and may create a bunch of new "friends" in your facility.

<b>Primary Address Setup</b>	Setup of the primary network interface
<b>Network Status</b>	[Offline / Connected + bandwidth]
<b>DHCP – Automatic IP Config.</b>	[OFF / ON]
<b>IP-Address</b>	
<b>Netmask</b>	
<b>DNS Server</b>	
<b>Gateway</b>	
<b>MAC Address</b>	
<b>Secondary Address Setup</b>	Setup of the secondary network interface
<b>Network Status</b>	[Offline / Connected + bandwidth]
<b>DHCP – Automatic IP Config.</b>	[OFF / ON]
<b>IP-Address</b>	
<b>Netmask</b>	
<b>DNS Server</b>	
<b>Gateway</b>	
<b>MAC Address</b>	[unknown / address]

**Important Note!** It may happen by accident that the update of the Dante module fails. E.g. if the firmware update option: SYSTEM > Firmware Update > Option Board Update is set to "Update option boards automatically ...." and the device loses power during this process, the Dante module will be in the fail-save state. This is indicated in the Dante Controller software.

In this case you must repair it by the help of a Dante tool. You can download it from the website: <https://www.audinate.com/content/dante-firmware-update-manager-v31009-windows>

Pls. keep in mind that the PC, that runs the Dante update manager must be in the Dante network (if you have separated the networks as recommended) and not in the device control network.

The update manager performs two tasks, the recovery from the fail-safe state and the update of a valid Junger basic firmware for the Dante module.

After you have managed to recover from fail-safe you must power cycle the **EASY LOUDNESS** and update the module manually to the latest Junger firmware using the Dante update manager. The file is part of the zip file that you can download from the Junger web-site.

You will find the Junger recovery firmware here (version numbers are examples only):

```
rel_dap4_mei_4_0_1.zip > junger_dap4_mei_firmware > Dante_recovery_image > DT-100-v1.0.3-7.dnt
```

## Setup GUI – Overview

The overview is presented on the **HOME** page of the **EASY LOUDNESS**:

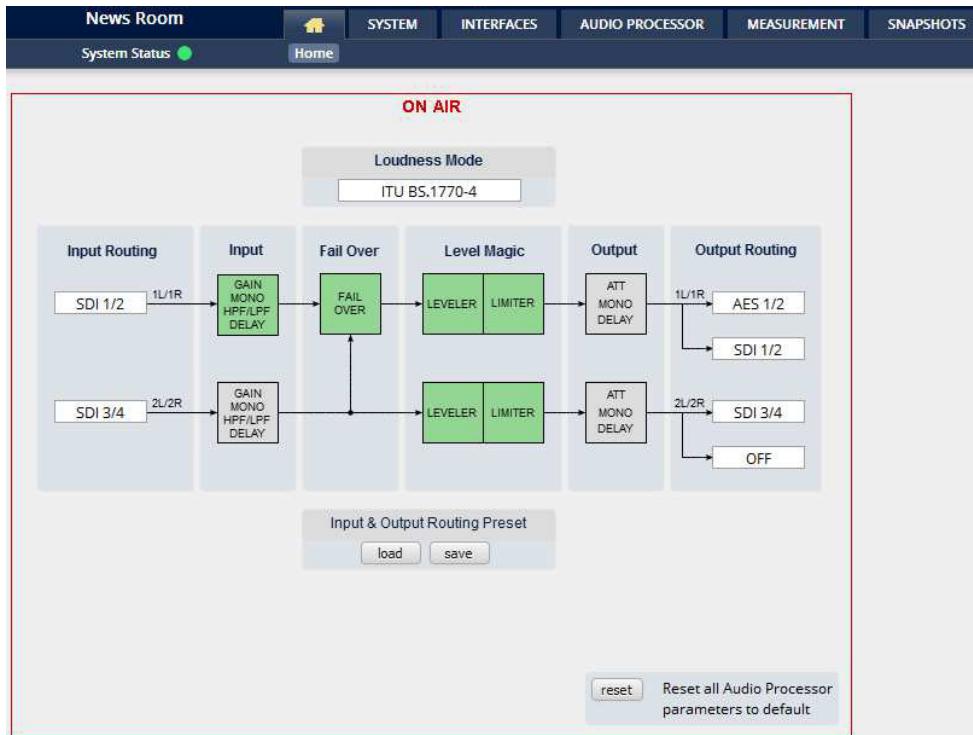

The processing blocks in use, which may be activated from their individual setup panes, will be indicated in green. I.e. blocks shown in grey are not activated by the user.

To navigate through the various processing blocks you may either click on the graphical block or use the sub tabs provided by the AUDIO PROCESSOR main tab.

### Loudness Mode

- ITU BS.1770-4**
- Level
- ITU BS.1770-1
- ITU BS.1770-2
- ITU BS.1770-3
- ITU BS.1770-4
- EBU R128
- ARIB TR-B32
- ATSC A/85 (2011)
- ATSC A/85 (2013)
- Free TV OP-59
- Portaria 354

In order to meet the regulations of regions or countries you must select the loudness control mode here.

Beside the weighting curves several measurement duration and loudness ranges have been defined. Some regulations are based on the same measurement (e.g. ITU BS.1770-2) but defined in a different regional norm. You must check with your local authority for correct settings if you must comply with regulations.

Setup GUI – AUDIO PROCESSOR – Input

You may set the input conditions for both program channels (1L/1R) and (2L/2R) here:

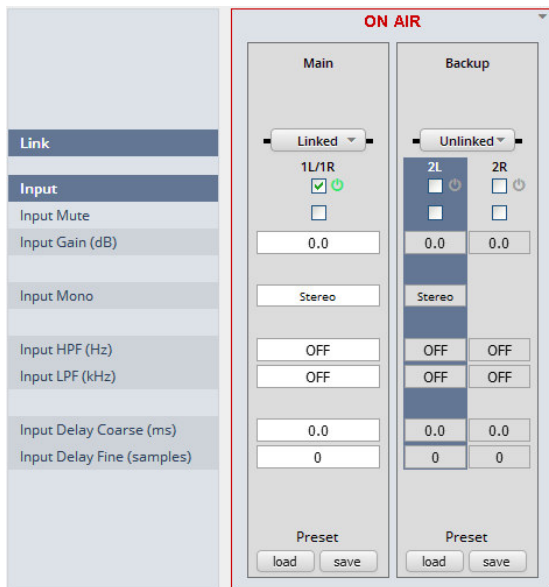

- Link** [Unlinked, Linked]  
For stereo operation you may link the setup parameters.
- Input** [Enable / Disable]  
enables or disables the input section.
- Mute** [ON / OFF]
- Input Gain (dB)** [-80.0 ... 0.0 ... 20.0]
- Mono** [L/R Stereo / L+R Mono / L/L Mono / R/R Mono]
- Input HPF (Hz)** [OFF / 20 / 40 / 80 / 120]
- Input LPF (kHz)** [OFF / 15 / 20 / 22]
- Input Delay Coarse (ms)** [0.0 ... 2000.0]
- Input Delay Fine (samples)** [0 ... 2000]

Setup GUI – AUDIO PROCESSOR – Fail Over

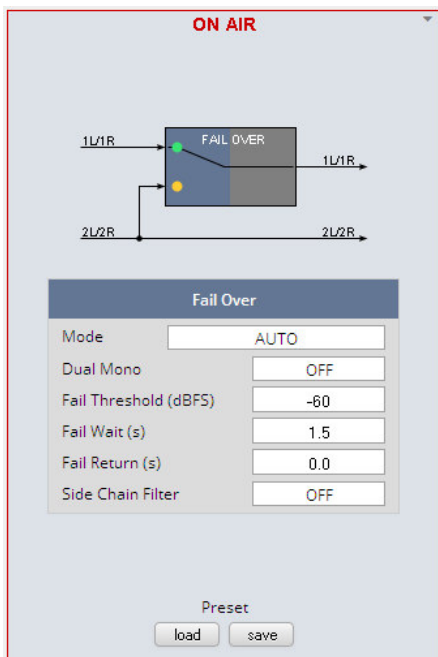

- Fail Over** The D\*AP4 offers a fail over circuit for automatic operation. It will switch to 2L/R in case 1L/1R fails.
- MODE** [FIX 1L/1R / FIX 2L/2R / AUTO]  
In AUTO mode the switch over happens in case of an input failure.
- Dual Mono** [OFF / AUTO]  
A detector looks after the input signal. If it is a left [L] or right [R] only it converts that signal either to [L/L] or [R/R].
- Fail Threshold (dBFS)** [-80 ... -60 ... -40]  
**RMS** weighted input level for fail detection.
- Fail Wait (s)** [1.5 ... 10.0]  
Elapsed time after fail detection until the switch over happens.
- Fail Return (s)** [0.0 ... 10.0]  
Elapsed time after detection of a proper input signal until it switches back to the program input.
- Side Chain Filter** [OFF / ON]  
A high pass filter (300Hz) and a low pass filter (3000Hz) is applied to the detector side chain (not the audio path), to prevent hum and noise from blocking fail over switching.

## Setup GUI – AUDIO PROCESSOR – Level Magic

This function block is used for loudness control of the program paths.



<b>Loudness Control Mode</b>	[display of the setting from AUDIO PROCESSOR > Setup > Loudness Mode]
<b>Link</b>	[unlinked / linked] defines the coupling of the control circuits
<b>Leveler</b>	[ON / OFF]
<b>Processing Profile</b>	[Live / Speech / Pop / Uni / Classic]
<b>Loudness Target for different modes</b>	Level [0 ... -50dBFS] ITU [0 ... -50LKFS] EBU[0 ... -50LUFS]
<b>Time (s/min/h)</b>	[10, 20, 40 / 1, 2, 5, 10, 20, 40 / 1, 2]
<b>Max Gain (dB)</b>	[0 ... 10 ... 40]
<b>Freeze Level (dBFS)</b>	[-60 ... -50 ... -20]
<b>Transient Processor</b>	
<b>Max Gain (dB)</b>	[0 ... 10 ... 15]
<b>Response</b>	[Soft, Mid, Hard]
<b>Response Boost</b>	<boost>
<b>Limiter</b>	[OFF / ON]
<b>Processing Profile</b>	[Live / Speech / Pop / Uni / Classic]
<b>Max True Peak (dBTP)</b>	[-20 ... -9.0 ... 0.0]

<b>Expert</b>	[ON / OFF]
<b>Clear Processing History</b>	<clear>
<b>Initial Dynamic Gain (dB)</b>	[-40 ... 0 ... 15]
<b>AGC Recovery</b>	[Fast / Normal]

<b>Low Level Behavior</b>	
<b>Processing Threshold (dBFS)</b>	[-80 ... -70 ... -20]
<b>Below Threshold Mode</b>	[Hold / Release]

For details regarding LevelMagic parameters see the bulletin: "Junger processing parameter description" on the Junger web site: <http://junger-audio.com/downloads>.

Setup GUI – AUDIO PROCESSOR – Output

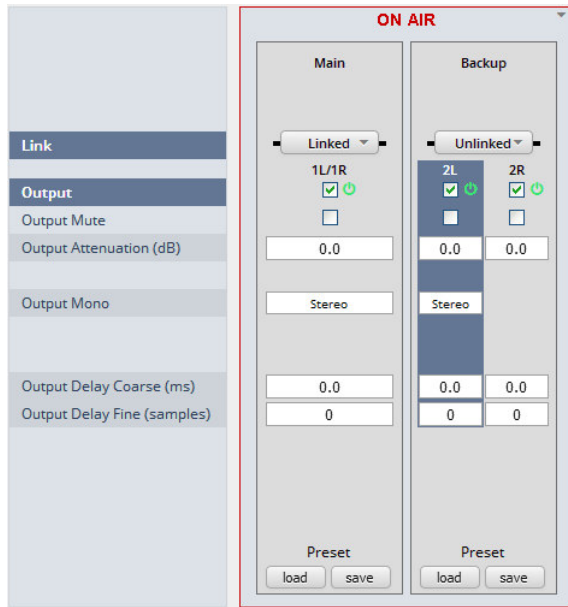

- Link** [unlinked / linked]  
defines the coupling of the control circuits
- Output** [ON / OFF]
- Output Mute** [ON / OFF]
- Output Attenuation (dB)** [-80.0 ... 0.0]
- Output Mono** [L+R Mono / LL Mono / RR Mono / Stereo]
- Output Delay Coarse (ms)** [0.0 ... 2000.0]
- Output Delay Fine (samples)** [0 ... 2000]

Setup GUI – MEASUREMENT – Loudness

The **EASY LOUDNESS LM** offers a sophisticated loudness measurement tool for the input and output of the program path of the device. The three control buttons **<pause>**, **<reset>**, **<reset max>** may be used to manually control the actual measurement. The pane shows the two measurement blocks for both programs:

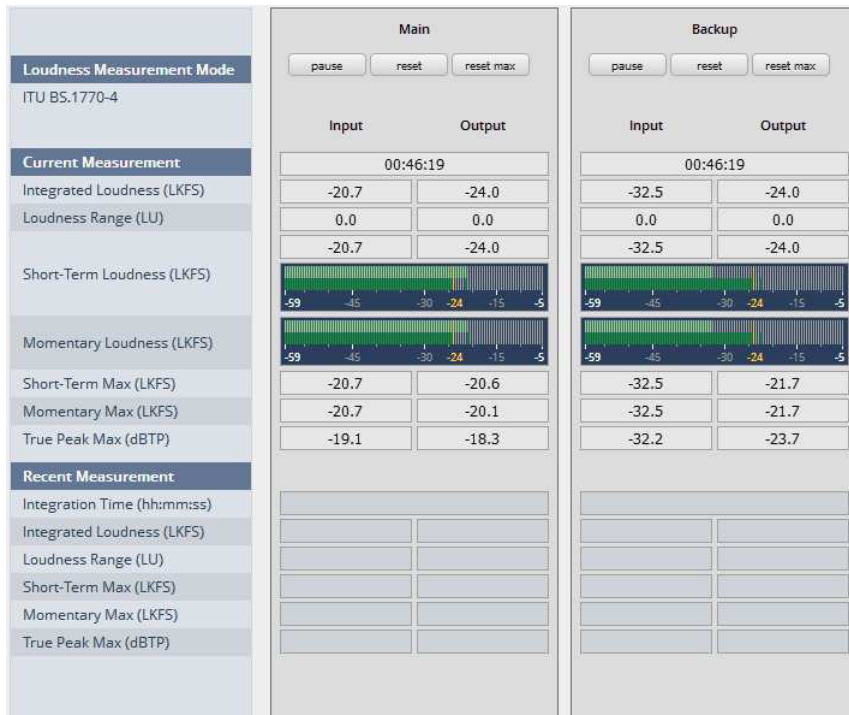

- Loudness Mode** [EBU R 128]  
setting from AUDIO PROCESSOR > Setup > Loudness Mode
- Current Measurement** [hh:mm:ss]  
Time elapsed since measurement started (excluding pauses)

**Integrated Loudness (LUFS)**

**Loudness Range (LU)**

**Short-Term Loudness (LUFS)** numeric and convenient bar graph display

**Momentary Loudness (LUFS)** numeric and convenient bar graph display

**Short Term Max (LUFS)**

**Momentary Max (LUFS)**

**True Peak Max (dBTP)**

**Recent Measurement**

[hh:mm:ss]

Total time of the recent measurement

**Important Note!** The measures of the parameters above depend on the loudness mode selected at the **Home** pane.

The measurement data may also be streamed to the **J\*AM** (Junger Application Manager) to feed the external loudness measurement and loudness logging tool. The **J\*AM** is a PC software package that you can download from the [Jungeraudio.com](http://Jungeraudio.com) web site. To perform loudness measurement and loudness logging one must buy a hardware (USB) dongle.



Setup GUI – **SNAPSHOTS**

As mentioned previously, **EASY LOUDNESS** includes a sophisticated **snapshot management** system. **Snapshots** may be triggered manually (via the **X\*AP RM1** remote panel Hotkeys or the **Mobile UI** Hotkeys), semi-automatically (triggered by network commands or hardware GPIs) and automatically (triggered by a System Status Error).

Trigger	Name	Routing Preset	Level Magic Preset Program 1	Level Magic Preset Program 2	Measurement	Test
GPI 1 / Hotkey 1	Default	-	Default	Default	-	Test
GPI 2 / Hotkey 2	Moderate	-	Moderate -24	Moderate -24	-	Test
GPI 3 / Hotkey 3	Universal	-	Universal	Universal	-	Test
GPI 4 / Hotkey 4	Heavy	-	Interstitials	Interstitials	-	Test
GPI 5 / Hotkey 5	Rt SDI Gr 1	SDI 1/2 + SDI 3/4	-	-	-	Test
GPI 6 / Hotkey 6	Rt SDI Gr 1+2	SDI 1/2 + SDI 5/6	-	-	-	Test
GPI 7 / Hotkey 7	Rt AES	AES to SDI	-	-	-	Test
System Status	System Status Error	AES to SDI	Default	Default	-	Test

- Trigger**  
  - GPI 1 / Hotkey 1 ....** Enumeration of the available snapshots. The physical GPI #1 or the Mobile UI Hotkey #1 or the X\*AP Hotkey that triggers the first snapshot
  - GPI 7 / Hotkey 7** See above.
  - System Status Error** An error will trigger that snapshot that in turn can set the SDI interface to bypass audio.



**Name** A label to distinguish between the different snapshots.

**Routing Preset** A preset can be selected here, that will change the signal routing. You may setup such preset at the **Home** pane or you may select one of the factory default presets available there:

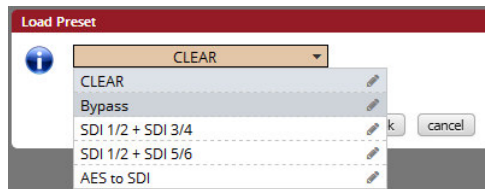

**Level Magic Preset Program 1** Will change the settings of the LevelMagic for the first program

**Level Magic Preset Program 2** Will change the settings of the LevelMagic for the second program

**Measurement** Controls the Loudness Measurement. You can Reset or Pause/Continue a measurement cycle:

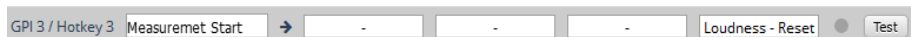

**Soft LED** Shows the status of that line (green = active)

**TEST** Pressing the respective button will test the recall of the presets for that line of settings.



## Technical Data - 4 Channel Audio Processor [EASY LOUDNESS]

General	<ul style="list-style-type: none"> <li>• 4 channel audio processor (2 stereo programs)</li> <li>• Expandable by hard and software options</li> </ul>		
Audio Sample Rate	44.1, 48, 88.2, 96kHz, (32 ... 196kHz @ input with SRC) ±150ppm sync input capture, ±25ppm master-sync stability		
AES/EBU Inputs	Relevant specifications comply with AES3-X-2009, IEC 60985 and AES11-2009		
	4 channels (2 stereo inputs), 2 XLR-3 connectors and 2 BNC connectors, alternative inputs - user settable input selector		
	24bits, transparent forwarding of PCM and compressed audio (w/o SRC) 24bits, PCM, sample rate converter (SRC) activated		
	Impedance	110Ohm differential (XLR-3) 75Ohm single-ended (BNC)	
	Input level	0.3 ... 5Vpp @ 110Ohm differential (XLR-3) 0.3 ... 5Vpp @ 75Ohm single-ended (BNC)	
	Sample Rate Converter (SRC)	THD+N -120dB @ 0dBFS, 1kHz Latency < 0.3ms	
AES/EBU Outputs	Relevant specifications comply with AES3-X-2009, IEC 60985 and AES11-2009		
	4 channels (2 stereo outputs), 2 XLR-3 connectors and 2 BNC connectors, both connector types carry the same signal		
	24bits, transparent forwarding of PCM and compressed audio		
	Impedance	110Ohm differential (XLR-3) 75Ohm single-ended (BNC)	
	Output voltage	3Vpp (typ.) @ 110Ohm differential (XLR-3) 1Vpp (typ.) @ 75Ohm single-ended (BNC)	
	Power fail relay bypass between AES/EBU inputs and outputs (can be deactivated by jumper)		
Sync Input	Multi-standard synchronization interface for AES/EBU, wordclock or video-sync (black burst, tri level), complies with AES11-2009 and relevant audio or video standards		
	Connector type	BNC	
	AES/EBU input	0.3 ... 5Vpp @ 75Ohm single-ended	
	Wordclock input	1 ... 5Vpp @ 75Ohm single-ended	
	Video-sync input	1Vpp (nom.) @ 75Ohm single-ended	
		Rates supported: 23.975, 24, 24.975, 25, 29.97, 30, 49.95, 50, 59.94, 60fps (SD and HD)	
	On-board audio ports and master-sync capable option boards may also be selectable as sync source.		
Sync Output	Word clock output, complies with AES11-2009		
	Connector type	BNC	

	Wordclock output	2.4V (typ.) @ 75Ohm single-ended
Network Interface	RJ45 connector, 10/100Mbit Ethernet auto sense, full duplex, auto MDI/X	
USB Interface	USB 2.0 connector to internal console interface	
GPI Signals	8 general purpose inputs (GPI), divided into 2 groups with separate common signal, isolated	
	Connector type	D-Sub25 connector female, same for GPO
	Input conditions	3 ... 24Vdc, < 5mA
	Auxiliary supply	5V (nom.), 200mA (max.), isolated
GPO Signals	8 general purpose outputs (GPO), SPST, divided into 2 groups with separate common signal, isolated	
	Connector type	D-Sub25 connector female, same for GPI
	Output conditions	24Vac/dc (max.), 120mA (max.)
Expansion Slot	1 general purpose expansion slot for option boards	
Power Supply	Dual power supply, automatic fail over, 85 ... 264Vac, 50 ... 60Hz, 58W (max.)	
Environmental	Operating temperature 0 ... 50°C, fan cooled, Non-operating -20 ... 70°C, Humidity < 90%, non-condensing	
Physical	19", 1 RU, 27 cm depth, net weight ca. 5 kg, shipping weight ca. 7.5 kg	

Technical Data – Option Board SDI I/O (3G/HD/SD) [O\_DAP\_SDI\_a]

Standards	Video complies with SMPTE 424/425M (3G, Level A and B), SMPTE 292M (HD) or SMPTE 259M (SD). Automatic format detection. Audio embedding and de-embedding complies with SMPTE 299M (3G, HD) or SMPTE 272M-AC (SD). Metadata embedding and de-embedding complies with SMPTE 2020-2.	
Video Data Rate	2970/2967Mbps (3G), 1485/1483.5Mbps (HD), 270Mbps (SD)	
Video Formats	1080p23.975, 24, 25, 29.97, 30, 50, 59.94, 60 1080i50, 59.94, 60 720p23.975, 24, 25, 29.97, 30, 50, 59.94, 60 625i50, 525i59.94, ...	
Video Delay	User selectable 0 ... 15frames, can be disabled	
Audio	24bits, transparent forwarding of PCM and compressed audio	
Audio Channels	16 inputs and 16 outputs (4 groups with 4 channels each)	
Audio Sample Rate	48kHz (SDI compliant)	
Audio Delay	Embedder audio delay selectable 0 ... 320 ms per channel	
Metadata (RDD6)	1 channel input and 1 channel output, SDID selectable	
BNC Input	Impedance	75Ohm
	Return loss	> 15dB, 5 ... 1485MHz > 10dB, 1485 ... 2970MHz
	Cable length (max.)	250m @ SD for Belden 1694A cable 230m @ HD for Belden 1694A cable 140m @ 3G for Belden 1694A cable

	Jitter tolerance	> 0.7UI (Alignment)
BNC Output	Impedance	75Ohm
	Output voltage	0.8Vpp (typ.)
	Return loss	> 15dB, 5 ... 1485MHz > 10dB, 1485 ... 2970MHz
	Output jitter	< 0.2UI (Alignment), < 0.5UI (Timing)
Audio Latency	Input to Output	Embedder and de-embedder combined HD, 3G < 0.6ms SD typ. 1.5ms (< 2 ms)
General Features	<ul style="list-style-type: none"> <li>• Power fail relay bypass (may be activated via GUI)</li> <li>• Lip-Sync compensation for processed and non-processed audio signals</li> <li>• Dedicated routing for non-processed channels, all channels (max. 16) can be routed to/from the device or looped through</li> <li>• Test pattern generator</li> <li>• Master-sync capable</li> <li>• ITU-R BT.1685 / ARIB STD-B39 metadata support</li> </ul>	

## Technical Data – Option Board Audio-over-IP DANTE™ I/O [O\_DAP\_DANTE\_a]

Standards	Audio-over-IP by Dante™ Digital Audio Networking Standard
Audio	24bits, transparent forwarding of PCM and compressed audio
Audio Sample Rate	44.1, 48, 88.2, 96kHz
Inputs and Outputs	2 x Gigabit Ethernet RJ45 connectors (100M/1Gbit), primary and secondary port
Inputs	Processable by D*AP8: 16 channels @ 44.1, 48kHz Processable by D*AP4: 8 channels @ 44.1, 48, 88.2, 96kHz
Outputs	Processable by D*AP8: 16 channels @ 44.1, 48kHz Processable by D*AP4: 8 channels @ 44.1, 48, 88.2, 96kHz
General Features	<ul style="list-style-type: none"> <li>• AES67 compliant</li> <li>• Network master-sync can be provided by D*AP device</li> <li>• Master-sync capable (for D*AP device)</li> <li>• Non-audio detection for input channels</li> <li>• Glitch-free Dante™ audio redundancy using dual Ethernet networks</li> </ul>

Technical Data - Rear Connectors - **pin assignment**

8x GPI/O

Mic / Line IN

connector:	GPI/O
female	25-pin D-Sub
1	GPI_1, 2, 3, 4 common
2	GPI_1
3	GPI_2
4	GPI_3
5	GPI_4
6	GPI_5, 6, 7, 8 common
7	GPI_5
8	GPI_6
9	GPI_7
10	GPI_8
11	
12	
13	Isolated 5V +
14	GPO_1, 2, 3, 4 common
15	GPO_1
16	GPO_2
17	GPO_3
18	GPO_4
19	GPO_5, 6, 7, 8 common
20	GPO_5
21	GPO_6
22	GPO_7
23	GPO_8
24	Isolated 5V -
25	Isolated 5V -

connector:	Mic / Line input
female	XLR
1	GND
2	IN +
3	IN -
Shield	Virtual GND

## Technical Data – GPI wiring

The device offers a unique circuitry to save GPI setups from hum and noise influence in complex installations. Here the principle circuit of one of the 8 GPI inputs:

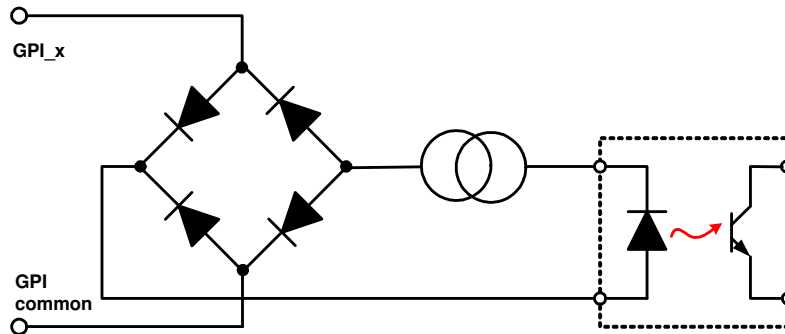

At the GPI input is a **bridge rectifier**, i.e. you do **not** need to care about the polarity of the input voltage. A **constant current source** in line with the **optical coupler** limits the current. You must simply provide a voltage in the range from 5 V to 30 V to activate a GPI.

If you have open collector outputs or simple relay closures as the driving GPOs (this technique is commonly known as "low active" and will be found in most legacy equipment), you must wire up an auxiliary voltage supply.

The device provides such auxiliary power supply. It offers a balanced 5 V source like a battery.

Here an example how to wire up GPI #4:

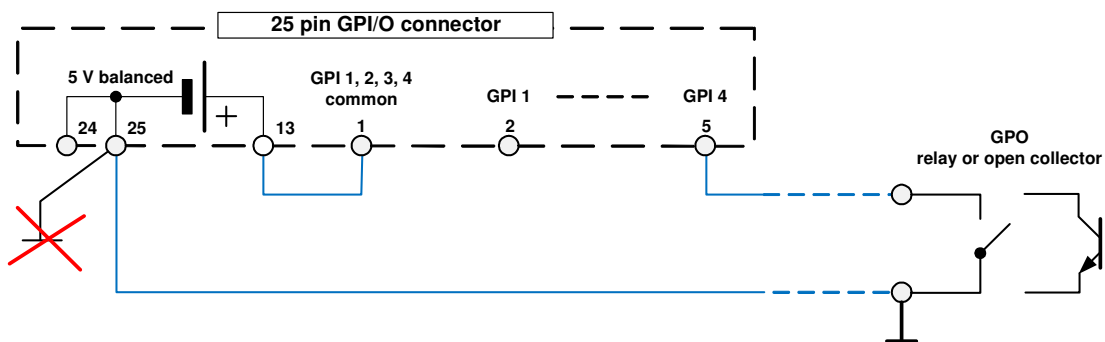

We strongly recommend providing a wire for ground connection instead of using the chassis common grounds of an installation.

**Safety Information**

Electrical

- Safety classification: Class 1 – grounded product / Schutzklasse 1  
Corresponding to EN 60065:2002
- Power connection: The device must be connected to a power socket that provides a protective earthing conductor.
- Power switch: The power switch is a toggle switch placed at the rear of the device. The ON / OFF position is indicated by engravings [I] / [O] on the lever. It must be reached without difficulty.  
The devices may be equipped with dual power supply, in this case it will have two power cords and switches. You must inform yourself about the location and assignment of the switches.
- Water protection: The device must not be exposed to splash or dripping water. It is permitted to place a container filled with liquids (e.g. vases) on top of the device.

Service safety

- Only qualified personnel should perform service procedures.
- Do not service alone: Do not perform internal service or adjustments of the device unless another person capable of rendering first aid and resuscitation is present.
- Disconnect power: To avoid electrical shock, switch off the device power, then disconnect the power cord from the mains power. Do not block the power cord; it must remain accessible to the user at all times

To avoid fire or personal injury

- Mounting: It must be placed on a flat surface or must be mounted into an 19" rack. It is recommended to use metal brackets (sheet steel angle) to support the device.
- Provide proper Ventilation: this case and if the device has a built in fan, a gap of at least 1cm must be left between the device edge and the steel angle. It is highly recommended to leave a gap of at least 1RU above and below the device.
- Use proper power cord: Use only the power cord specified for this product and certified for the country of use.
- Do not operate without covers: Do not operate this product with covers or panels removed.
- Do not operate with suspected failures: If you suspect that there is damage to this product, have it inspected by qualified service personnel.
- Risk of explosion: The device contains a lithium battery. If replaced incorrectly or by a different or inadequate type an explosion may occur.

**Warranty**

Standard Junger Audio one-year warranty on parts and labor.

Specifications are subject to change without notice





## Headquarters

Jünger Audio GmbH  
Sales • Service & Support  
Justus-von-Liebig-Str. 7  
12489 Berlin, Germany  
phone +49 30 677 721 0  
fax +49 30 677 721 46  
support@jungeraudio.com  
sales@jungeraudio.com  
www.jungeraudio.com

## Jünger Audio Asia

Junger Audio Pte. Ltd.  
Sales • Service & Support  
33, Ubi Ave 3, no. 06-62 Vertex  
408868 Singapore  
phone +65 6509 8171  
fax +65 6748 1740  
asia@jungeraudio.com

## Jünger Audio (China Office)

Junger (Beijing) Technology Ltd.  
Sales • Service & Support  
Unit 068, 2nd Floor, No. 38 GuangQu Road,  
ChaoYang District, 100021 Beijing, China  
phone +86 137 0102 6664  
china@jungeraudio.com

## Jünger Audio USA

Service & Support  
2100 B2 Walsh Ave  
Santa Clara, CA 95050-2590, USA  
phone +1 408 330 9215  
usa@jungeraudio.com



 [www.facebook.com/jungeraudio](http://www.facebook.com/jungeraudio)

 [www.twitter.com/jungeraudio](http://www.twitter.com/jungeraudio)